



**NEWGARDEN**







# Light & Deco.

FLOOR LAMPS	OKINAWA 170	19	PORTABLE HANGING LAMPS	GARLAND LIFT	105
	SANTORINI	21		EDY	107
	NIZA 165	23		CONTA MINI	108
	NIZA 230	25		NEO	109
	AMALFI 145	27		ELBA	111
	LOLA SLIM 120 / 180	29		MYKONOS	113
	CHLOE PLANT	31		CONTA	114
	CHLOE 140	33		POSITANO	115
	ROCKET 70	35		OKINAWA	117
	ROCKET 145	35		BOSSA	118
TABLE LAMPS & DECORATIVE	FITY 100	37	SISINE	119	
	FITY 160	37	CALOBRA	120	
	PANCHO	39	REONA	121	
	LOLA 110 / 165 / 200	41	BENIRRÁS	122	
	CARMEN 110/165	45	SAONA	123	
	FREDO 110 / 170	47	PIANETA 25/ 35 /45	125	
	KONIKA	49	BITA	127	
	GRACE 140 / 170	51	SORA	127	
	KAKTUS	53	NORAI	127	
	OKINAWA LANTERN	55	KURBY	129	
GARLANDS	SIROCO 30/50	57	NÓMADA	130	
	HIAMA	59	CUBY 45 PLAY	131	
	GRETITA TABLE	65	CHERRY	133	
	GRETITA TABLE SOLAR	65	SOLAR CHERRY	133	
	CONTA 30/70	67	CHERRY MINI	135	
	SAONA 30/70	69	COCO	137	
	SISINE 30/70	71	BANANA	138	
	BOSSA 30	72	LIMA	139	
	OKINAWA TABLE LAMP	73	GRETITA	61	
	CHLOE 35	74	GRETA	63	
SWIMMING POOLS	JACK LUX	75	ROLL 8	140	
	LOLA 12 LUX	76	ROLL 4	141	
	LOLA 20 LUX	77	ROLL ACCESSORY	142	
	SHITAKE	78	BOX 8	143	
	MAIA	79	PEPITA	145	
	SARDINIA 30/40	81	PAQUITA	147	
	CANDY	83	SUNSET	149	
	NORAI SLIM 35	85	WALLY SQUARE	151	
	LOLA SLIM 30	87	WALLY DISK	153	
	ROCKET 20	88	BOSSA WALL	154	
ESSENTIALS	PANCHITO	89	SISINE WALL	155	
	LOLA 20 / 30 / 45	91	SAONA WALL	156	
	ALLEGRA	93	CONTA WALL	157	
	STELLA	94	BULY	159	
	MYKONOS	95	PETRA	163	
	AURORA	96	CUBY	165	
	ALBA	97	PAPAYA 12	168	
	HIAMA	98	PAPAYA 30	169	
	OKINAWA	99	BULY FLOATING	170	
	BRUNA	100	PLAY DISK 40	171	
FUNCTIONALS	CHELSEA	102	INDOOR & CHRISTMAS	175	
	LUCEO	103			

# Furniture.

RASA	183
FORMENTERA	185
NEW ISLAND	189
TARIDA	191
TAFY & CUBY	194
TAFY & PUFY	195
CAPRI 40 & CORFU 40	197
CAPRI 75 & MALLORCA	199
CAPRI 110 & CORFU 74	201
ITACA & MALLORCA	203
BORA	205
SICILIA 75 / 120	207
IBIZA 120	209
CRETA 120	211
PALMA BOTTLE	212
WOODY	213

# Flowerpots.

AZALEA	217
HORTENSIA	219
MAGNOLIA	222
MELISA	228
PALMA 70	231
FICUS	233
BAMBÚ	235
JARA	236
JUNCO	237
NARCISO	239
GERBERA	240
CAMELIA	241
JAZMÍN	248
CLAVEL	249
VIOLETA	251
GIRASOL	252
CALÉNDULA	253
CAMOMILA	254
PETUNIA	255
ROSA	257
PLATES	259

# Circoolar by Newgarden.

CIRCOOLAR By Newgarden	10
RASA	183
TARIDA SET	191
CUBY 53	194
TAFY	195
HORTENSIA	219
CAMELIA	242





**Crafting**  
**your**  
*indoor and*  
*outdoor*  
**moments.**





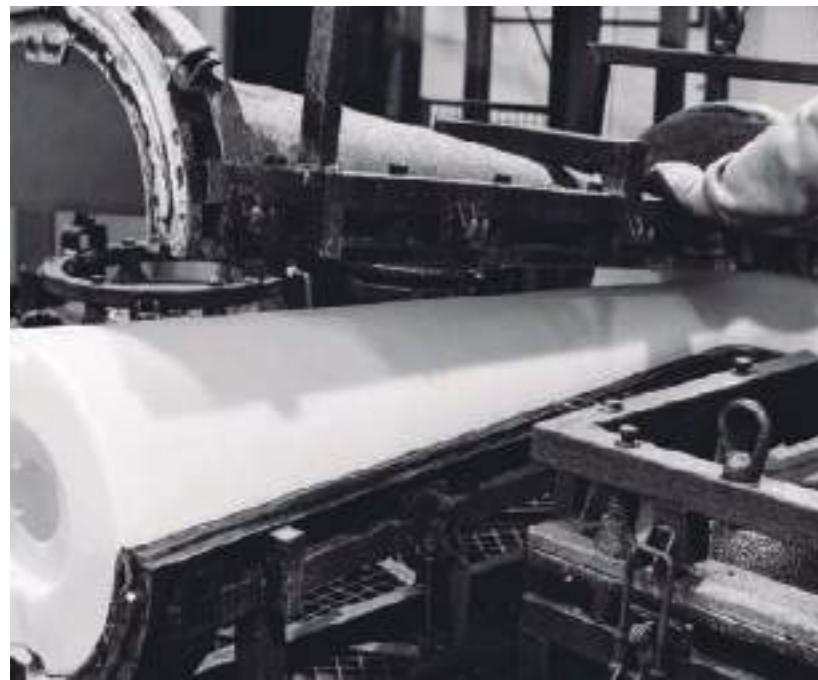
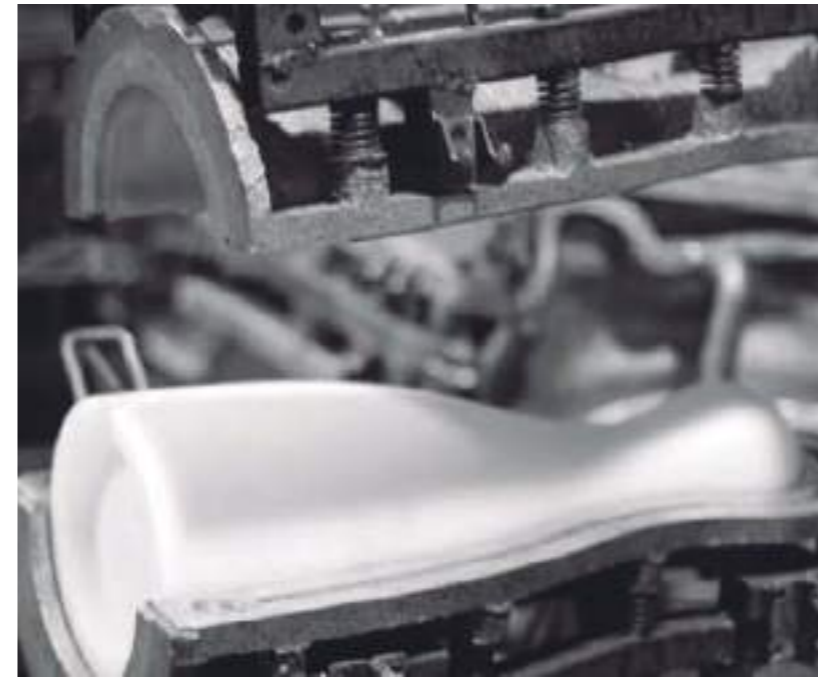
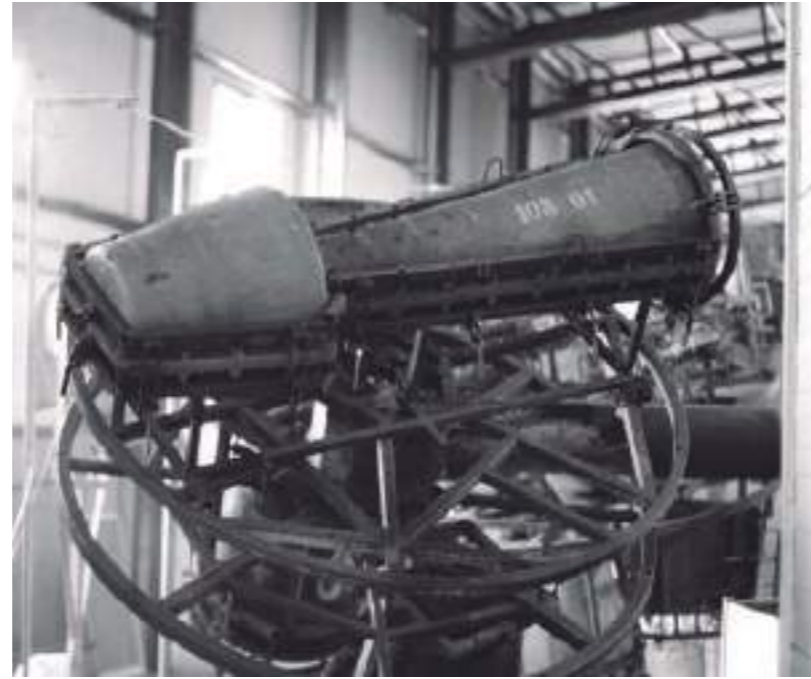

**European**  
*manufacturers*  
*and designers*  
**of moments.**



# A different way of embracing sustainability.

WE HAVE OUR OWN VISION OF SUSTAINABILITY, INTRODUCING CIRCOOLAR BY  
NEWGARDEN.

SUSTAINABILITY IS MUCH MORE THAN RECYCLING. IT IS MUCH MORE THAN  
USING LED LIGHTS. IT IS MUCH MORE THAN BEING MANUFACTURERS.

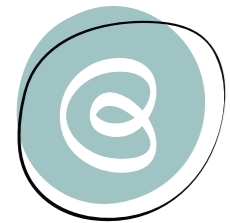

**CIRCOOLAR**

By Newgarden

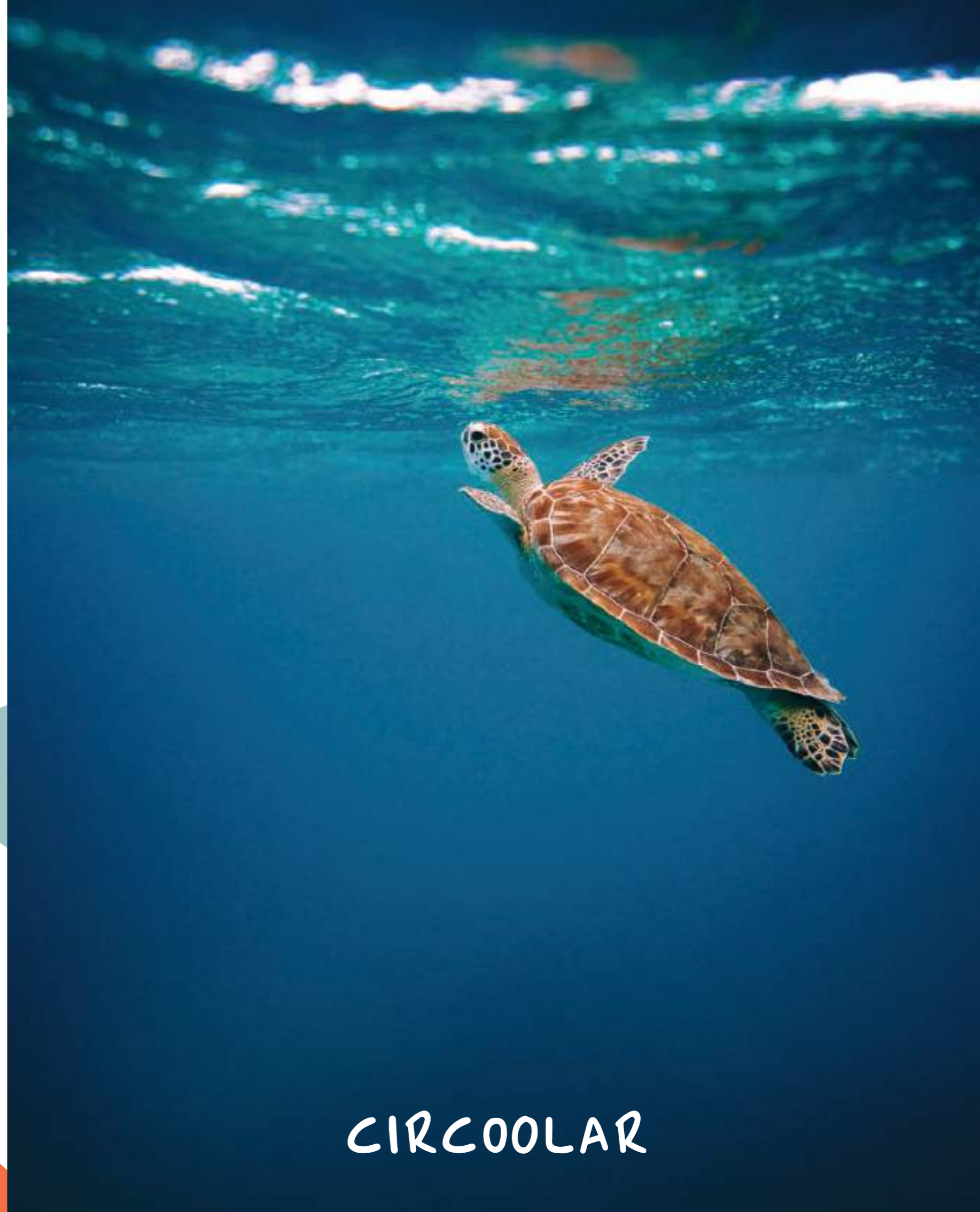

CIRCOOLAR





# Another sustainability can be is possible

CIRCOOLAR   
By Newgarden

MADE FROM FISHING NETS RETRIEVED FROM THE MEDITERRANEAN SEA



RESPONSIBLY MADE FURNITURE AND LIGHTING

PROUD TO BE SPANISH MANUFACTURERS



PRODUCTS | CIRCOOLAR

(1) TARIDA SET | PAG 191  
(4) RASA | PAG 182

(2) TAFY & CUBY 53 | PAG 194  
(5) CAMELIA | PAG 241

(3) HORTENSIA | PAG 218



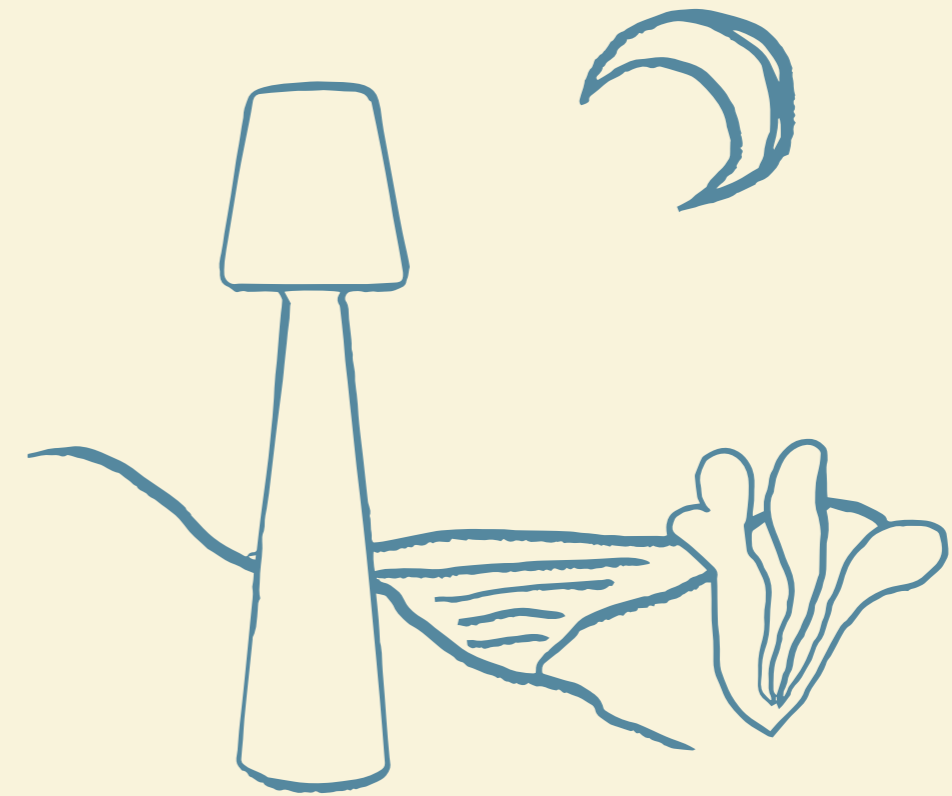

*Light & Deco*



# Candlelight DINNER

## PRODUCTS

- (1) BOSSA
- (2) EDY G125
- (3) AURORA
- (4) MALLORCA
- (5) SAONA 70
- (6) SISINE
- (7) POSITANO
- (8) HIAMA
- (9) CAPRI





# Okinawa.



## OKINAWA 170 | NATURE COLLECTION

SOLAR & RECHARGEABLE BATTERY

REF: LUMOKI170XXSWNW

- IP54 Outdoor & Indoor use
- Solar + Rechargeable Battery (driver not included)
- Warm Light (included)
- 900 lm
- Remote control (included)

- Dimmable
- Rechargeable bulb Cherry (included)
- Bamboo
- Packaging: 50 x 47 x 47 cm
- Gross Weight (with packaging): 8,5kg

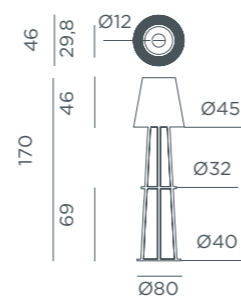

Dimensions (cm)





Santorini.  
Santorini.  
Santorini.



**SANTORINI | NATURE COLLECTION**

**RECHARGEABLE BATTERY**

- IP54 Outdoor & Indoor use
- 🔋 Rechargeable Battery Electric Charge (driver not included)
- 💡 Warm Light (included)
- lm 900 lm
- 📡 Remote control (included)

REF: LUMSTN165BXWLNW

- 🔊 Dimmable
- 🔋 Rechargeable bulb Cherry (included)
- 🪵 Rattan & Lacquered Steel (white colour)
- 📦 Packaging: 34,9 x 45 x 37 cm
- 📦 Gross Weight (with packaging): 6,7kg

Floor lamp & wall lamp  
2 lamps in 1

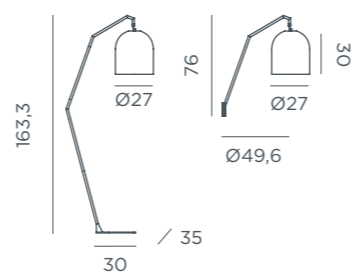

Dimensions (cm)





# Niza 165.

**NIZA 165** | NATURE COLLECTION

**RECHARGEABLE BATTERY**

**REF: LUMNIZ165NXWLNW**

IP54 Outdoor & Indoor use

Rechargeable Battery Electric Charge (driver not included)

Warm Light (included)

lm 900 lm

Remote control (included)

Dimmable

Rechargeable bulb Cherry (included)

Seagrass | Lacquered Iron (black colour)

Packaging: 28 x 43,9 x 47,5 cm

Gross Weight (with packaging): 6,7kg

**Floor lamp & wall lamp**

2 lamps in 1

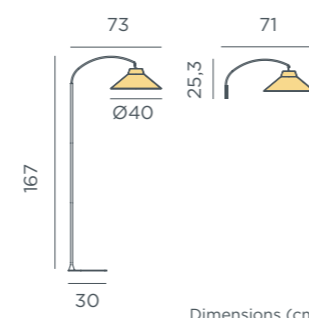





# Niza 230.



Floor lamp & wall lamp  
2 lamps in 1

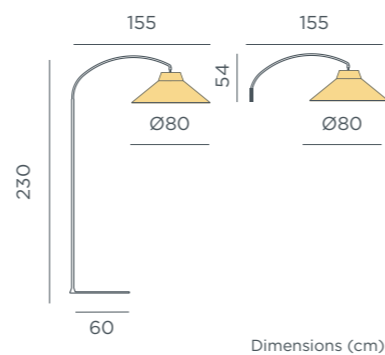

## NIZA 230 | NATURE COLLECTION

### RECHARGEABLE BATTERY

- IP54 Outdoor & Indoor use
- Rechargeable Battery Electric Charge (driver not included)
- Warm Light (included)
- 900 lm
- Remote control (included)

REF: LUMNIZ230BXWLNW

- Dimmable
- Rechargeable bulb Cherry (included)
- Seagrass | Lacquered Iron (black colour)
- Packaging: 82,5 x 92,5 x 46,5 cm
- Gross Weight (with packaging): 19,3kg







# Amalfi.

## AMALFI | NATURE COLLECTION

### RECHARGEABLE BATTERY

- 4 Outdoor & Indoor use
- 🔋 Rechargeable Battery Electric Charge (driver not included)
- 💡 Warm Light (included)
- 💡 900 lm
- 📶 Remote control (included)

REF: LUMAMA145BXWLNW

- 🔊 Dimmable
- 💡 Rechargeable bulb Cherry (included)
- 📏 Rattan | Lacquered Iron (black colour)
- 📦 Packaging: 63,8 x 52 x 57 cm
- 📦 Gross Weight (with packaging): 8,36kg

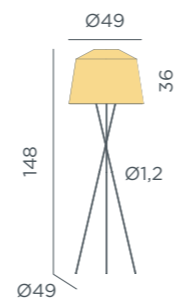

Dimensions (cm)













# Lola Slim 120.

## LOLA SLIM 120

### SOLAR & RECHARGEABLE BATTERY

- IP65 Outdoor & Indoor use
-  Solar + Rechargeable Battery (driver not included)
-  Warm Light (included)
-  White Light (included)
-  RGB Light (included)
- Im 600 lm
-  Remote control (included)
-  Dimmable
-  Twilight sensor
- M Lacquered Iron | Polyethylene
-  Packaging: 39 x 39 x 39,5 cm
-  Gross Weight (with packaging): 7kg



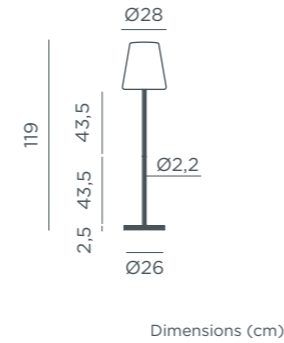





- Rose gold |  REF: LUMLLS120RGSSNW
- Brass |  REF: LUMLLS120BRSSNW
- Space grey |  REF: LUMLLS120GESSNW
- Anthracite |  REF: LUMLLS120ANSSNW



# Lola Slim 180.

## LOLA SLIM 180

### SOLAR & RECHARGEABLE BATTERY

- IP65 Outdoor & Indoor use
-  Solar + Rechargeable Battery (driver not included)
-  Warm Light (included)
-  White Light (included)
-  RGB Light (included)
- Im 800 lm
-  Remote control (included)
-  Dimmable
-  Twilight sensor
- M Lacquered Iron | Polyethylene
-  Packaging: 47 x 54 x 58,5 cm
-  Gross Weight (with packaging): 19,64kg

- Rose gold |  REF: LUMLLS180RGSSNW
- Brass |  REF: LUMLLS180BRSSNW

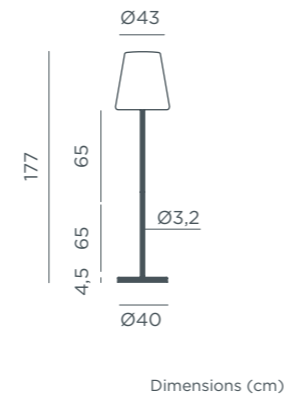

### JUTE CABLE

- IP65 Outdoor & Indoor use
-  Warm Light (included)
-  White Light (included)
- Im 860 lm
-  Remote control (included)
-  Dimmable
- M Lacquered Iron | Polyethylene
-  Packaging: 47 x 54 x 58,5 cm
-  Gross Weight (with packaging): 19,64kg

- Rose gold |  REF: LUMLLS180RGINOUTNW
- Brass |  REF: LUMLLS180BRINOUTNW

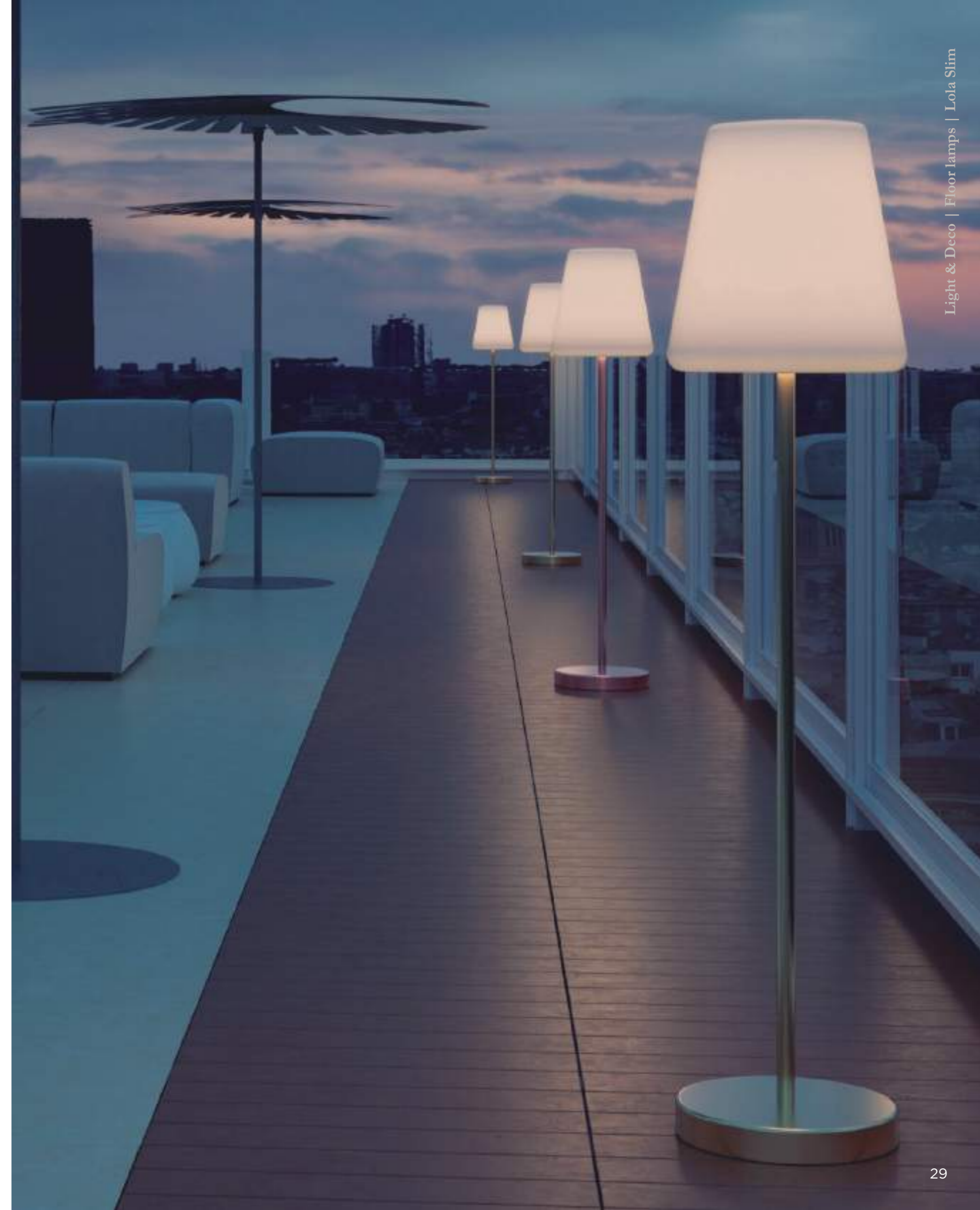



# Chloe Plant.



## CHLOE PLANT

SOLAR & RECHARGEABLE BATTERY

REF: LUMCHLPLTSSNW

- IP65 Outdoor & Indoor use
- Rechargeable Battery Electric Charge (driver not included)
- Warm Light (included)
- White Light (included)
- RGB Light (included)
- 600 lm

- Remote control (included)
- Dimmable
- Twilight sensor
- Lacquered Iron (wood colour) | Polyethylene
- Packaging: 46 x 46 x 39 cm
- Gross Weight (with packaging): 13,5kg

5 lamps in 1

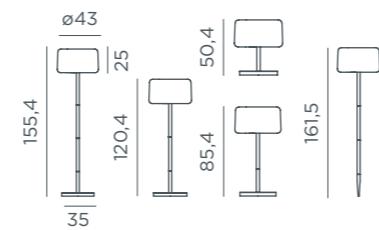

Dimensions (cm)



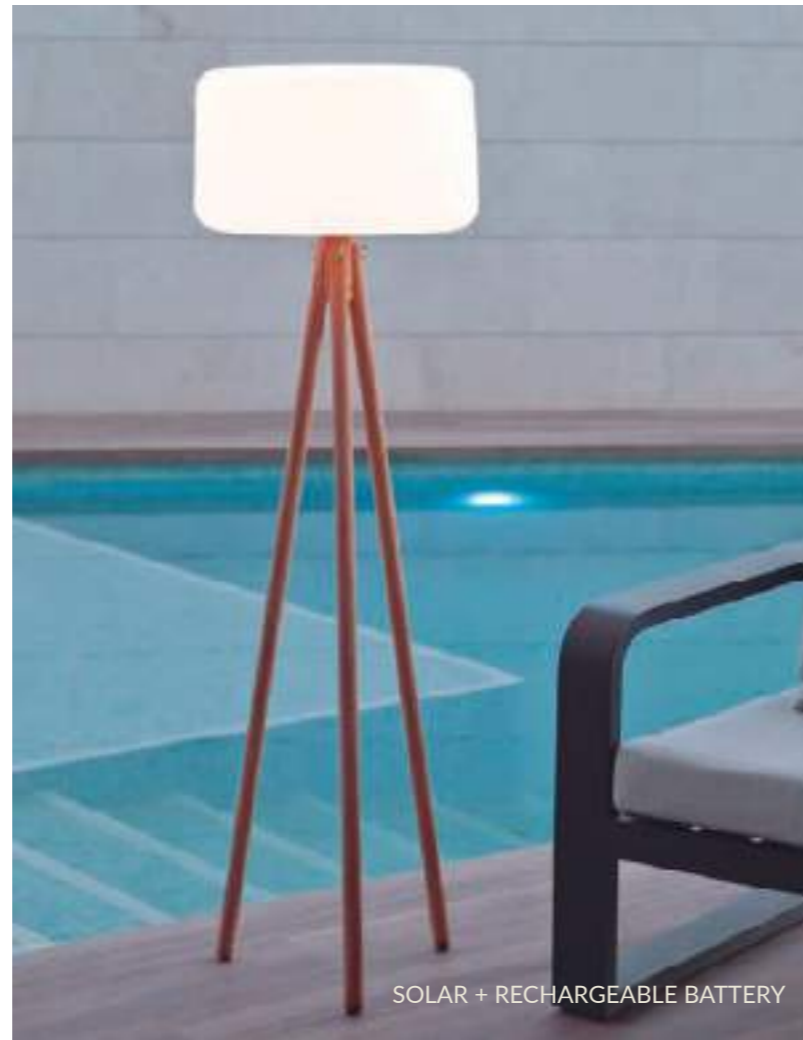

SOLAR + RECHARGEABLE BATTERY

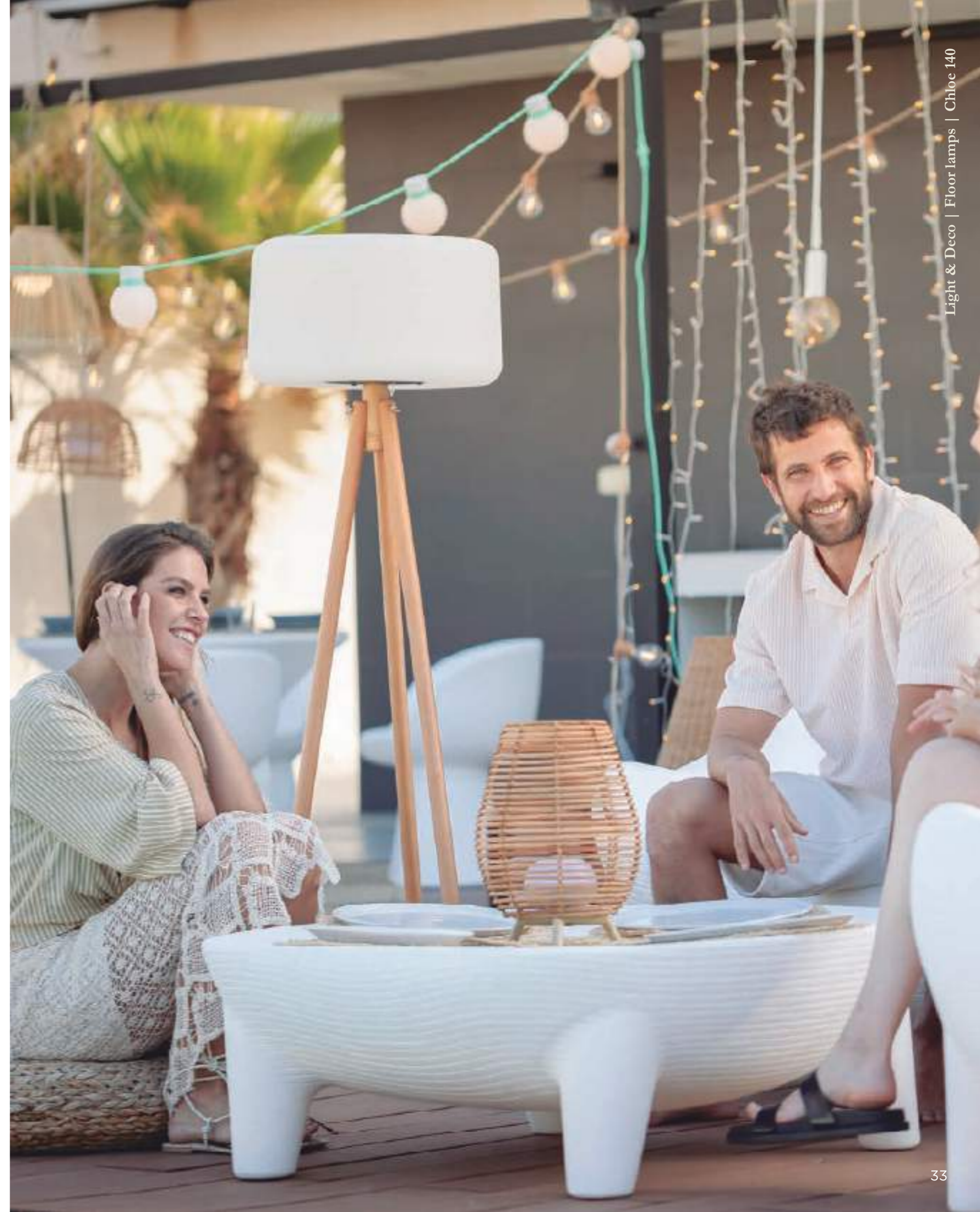

Light & Deco | Floor lamps | Chloe 140

# Chloe 140.

## CHLOE 140

### SOLAR & RECHARGEABLE BATTERY

REF: LUMCHL140SSNW

- Outdoor & Indoor use
- Solar + Rechargeable Battery (driver not included)
- Warm Light (included)
- White Light (included)
- RGB Light (included)
- 600 lm

- Remote control (included)
- Dimmable
- Twilight sensor
- Beechwood | Polyethylene
- Packaging: 31,6 x 46 x 123 cm
- Gross Weight (with packaging): 5,2kg

### JUTE CABLE

REF: LUMCHL140INOUTNW

- Outdoor & Indoor use
- Warm Light (included)
- White Light (included)
- 860 lm
- Remote control (included)

- Dimmable
- Beechwood | Polyethylene
- Packaging: 31,6 x 46 x 123 cm
- Gross Weight (with packaging): 5,2kg

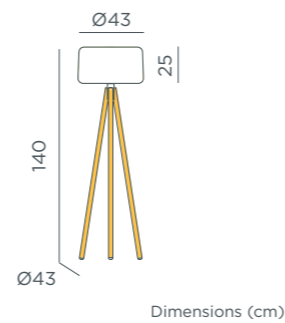















# Rocket 70.

## ROCKET 70

### SOLAR & RECHARGEABLE BATTERY

REF: LUMRCK70SSNW





-  Outdoor & Indoor use
-  Solar + Rechargeable Battery (driver nor included)
-  Warm Light (included)
-  White Light (included)
-  RGB Light (included)
-  600 lm

-  Remote control (included)
-  Dimmable
-  Twilight sensor
-  Beechwood | Polyethylene
-  Packaging: 37,5 x 37,5 x 43 cm
-  Gross Weight (with packaging): 3kg

### JUTE CABLE

REF: LUMRCK070INOUTNW

-  Outdoor & Indoor use
-  Warm Light (included)
-  White Light (included)
-  860 lm
-  Remote control (included)

-  Dimmable
-  Beechwood | Polyethylene
-  Packaging: 37,5 x 37,5 x 43 cm
-  Gross Weight (with packaging): 3kg

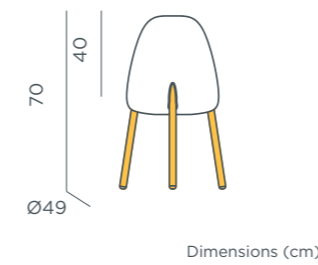

ROCKET 70

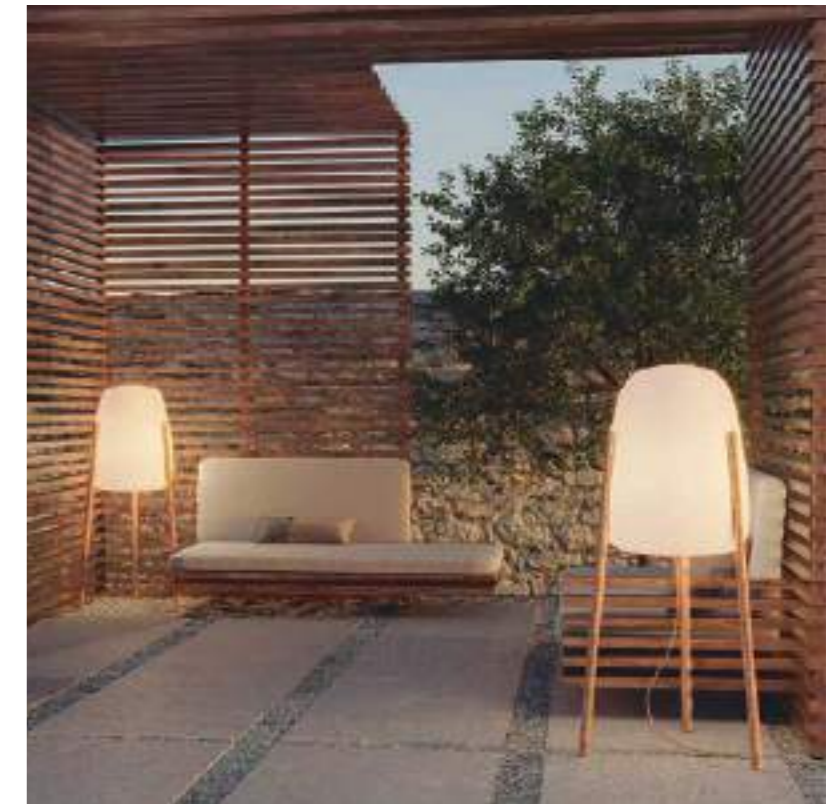







ROCKET 145





# Rocket 145.

## ROCKET 145

### SOLAR & RECHARGEABLE BATTERY

REF: LUMRCK145SSNW

-  Outdoor & Indoor use
-  Solar + Rechargeable Battery (driver nor included)
-  Warm Light (included)
-  White Light (included)
-  RGB Light (included)
-  600 lm

-  Remote Control (included)
-  Dimmable
-  Twilight sensor
-  Beechwood | Polyethylene
-  Packaging: 51 x 50,5 x 120,5 cm
-  Gross Weight (with packaging): 8kg

### JUTE CABLE

REF: LUMRCK145INOUTNW

-  Outdoor & Indoor use
-  Warm Light (included)
-  White Light (included)
-  860 lm
-  Remote control (included)

-  Dimmable
-  Beechwood | Polyethylene
-  Packaging: 51 x 50,5 x 120,5 cm
-  Gross Weight (with packaging): 8,2kg

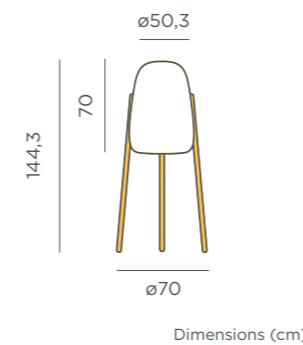



# Fity 100.

## FITY 100

### RECHARGEABLE BATTERY

REF: LUMFT100TWLNW

- IP65 Outdoor & Indoor use
- Rechargeable Battery Electric Charge (driver nor included)
- White Light (included)
- RGB Light (included)
- 110 lm
- Remote control (included)

- Dimmable
- Led tube lighting (included)
- M Polyethylene
- Packaging: 19,7 x 19,7 x 102 cm
- Gross Weight (with packaging): 4,7kg

### JUTE CABLE

REF: LUMFT100OFNW

- IP65 Outdoor & Indoor use
- White Light (included)
- 1.400 lm
- Led tube lighting (included)

- M Polyethylene
- Packaging: 19,7 x 19,7 x 102 cm
- Gross Weight (with packaging): 4,7kg

### JUTE CABLE

REF: LUMFT100OCNW

- IP65 Outdoor & Indoor use
- Warm Light (included)
- 1.400 lm
- Led tube lighting (included)

- M Polyethylene
- Packaging: 19,7 x 19,7 x 102 cm
- Gross Weight (with packaging): 4,7kg

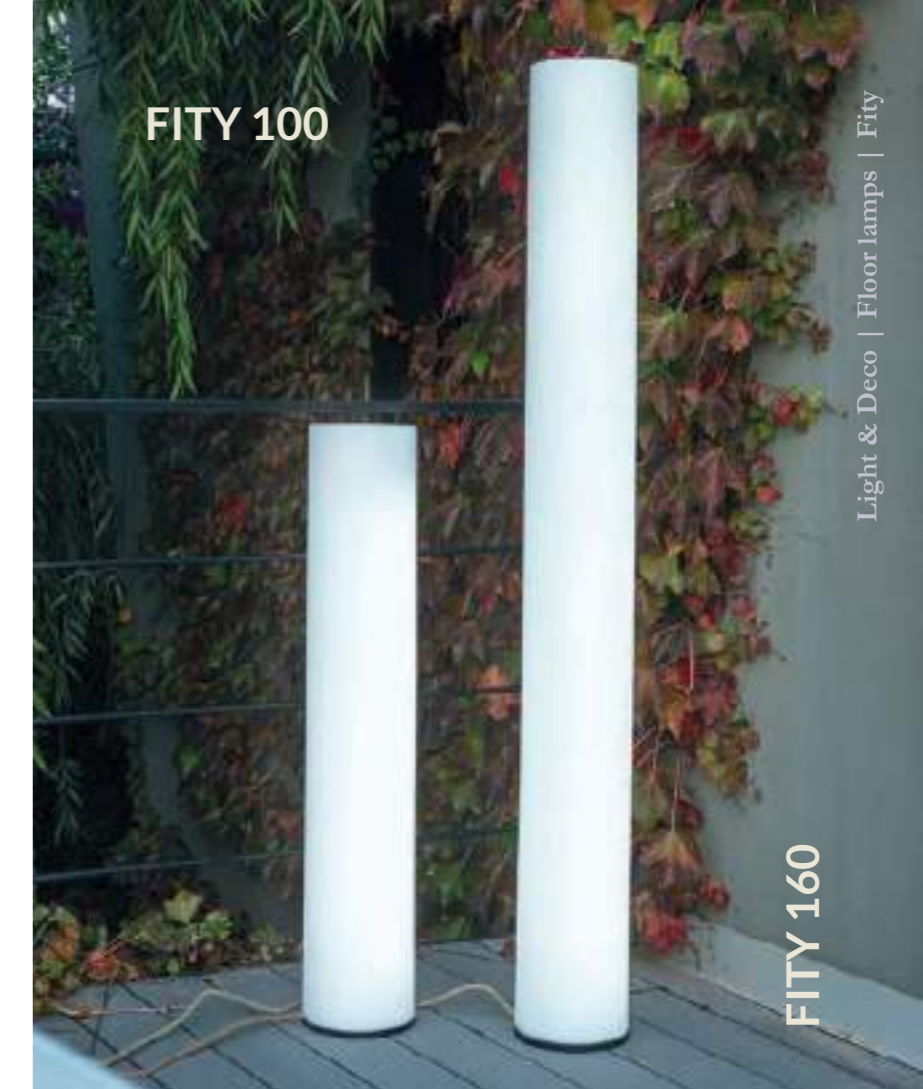

# Fity 160.

## FITY 160

### RECHARGEABLE BATTERY

REF: LUMFT160TWLNW

- IP54 Outdoor & Indoor use
- Rechargeable Battery Electric Charge (driver nor included)
- White Light (included)
- RGB Light (included)
- 135 lm
- Remote control (included)

- Dimmable
- Led tube lighting (included)
- M Polyethylene
- Packaging: 19,5 x 19,5 x 163 cm
- Gross Weight (with packaging): 6,2kg

### JUTE CABLE

REF: LUMFT160OFNW

- IP65 Outdoor & Indoor use
- White Light (included)
- 2.200 lm
- Led tube lighting (included)

- M Polyethylene
- Packaging: 19,5 x 19,5 x 165 cm
- Gross Weight (with packaging): 6,2kg

### JUTE CABLE

REF: LUMFT160OCNW

- IP65 Outdoor & Indoor use
- Warm Light (included)
- 2.200 lm
- Led tube lighting (included)

- M Polyethylene
- Packaging: 19,5 x 19,5 x 165 cm
- Gross Weight (with packaging): 6,2kg

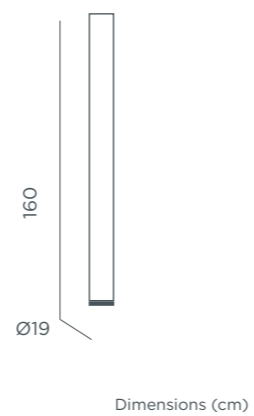





# Pancho.

## PANCHO 140

### RECHARGEABLE BATTERY

White |  REF: LUMPC140TWNW

- IP54 Outdoor & Indoor use
- Rechargeable Battery Electric Charge (driver not included)
- White Light (included)
- RGB Light (included)
- 115 lm
- Remote control (included)

- Dimmable
- Led tube lighting (included)
- Polyethylene
- Packaging: 44 x 51 x 140 cm
- Gross Weight (with packaging): 7kg

### CABLE

- IP65 Outdoor & Indoor use
- White Light (included)
- 1.800 lm
- Led tube lighting (included)
- Polyethylene
- Packaging: 44 x 51 x 140 cm
- Gross Weight (with packaging): 7kg

White |  REF: LUMPC140OFNW  
Lime |  REF: LUMPV140OFNW

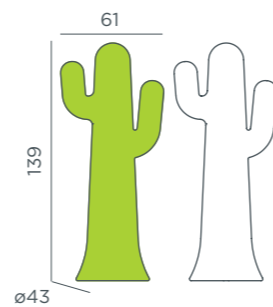

Dimensions (cm)

### CABLE

White |  REF: LUMFT1000CNW

- IP65 Outdoor & Indoor use
- Warm Light (included)
- 1.800 lm
- Led tube lighting (included)

- Polyethylene
- Packaging: 44 x 51 x 140 cm
- Gross Weight (with packaging): 7kg





# Lola.



LOLA 200



LOLA 165





# Lola 110.

## LOLA 110

### RECHARGEABLE BATTERY

REF: LUMLL110WLNW

IP65 Outdoor & Indoor use

🔋 Rechargeable Battery Electric Charge (driver not included)

☀️ White Light (included)

🌈 RGB Light (included)

lm 110 lm

📶 Remote control (included)

📶 Dimmable

💡 Led tube lighting (included)

M Polyethylene

📦 Packaging: 27,5 x 27,5 x 112 cm

📦 Gross Weight (with packaging): 4,2kg

### CABLE

REF: LUMLL110OFNW

IP65 Outdoor & Indoor use

☀️ White Light (included)

lm 1.600 lm

💡 Led tube lighting (included)

M Polyethylene

📦 Packaging: 27,5 x 27,5 x 112 cm

📦 Gross Weight (with packaging): 4,2kg

### CABLE

REF: LUMLL110OCNW

IP65 Outdoor & Indoor use

🌞 Warm Light (included)

lm 1.600 lm

💡 Led tube lighting (included)

M Polyethylene

📦 Packaging: 26,5 x 26,5 x 111,5 cm

📦 Gross Weight (with packaging): 4,2kg

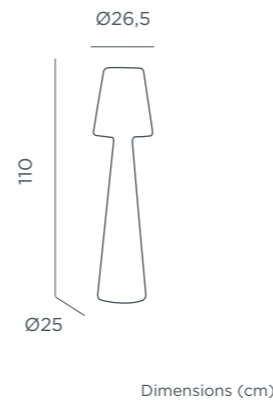

LOLA 165

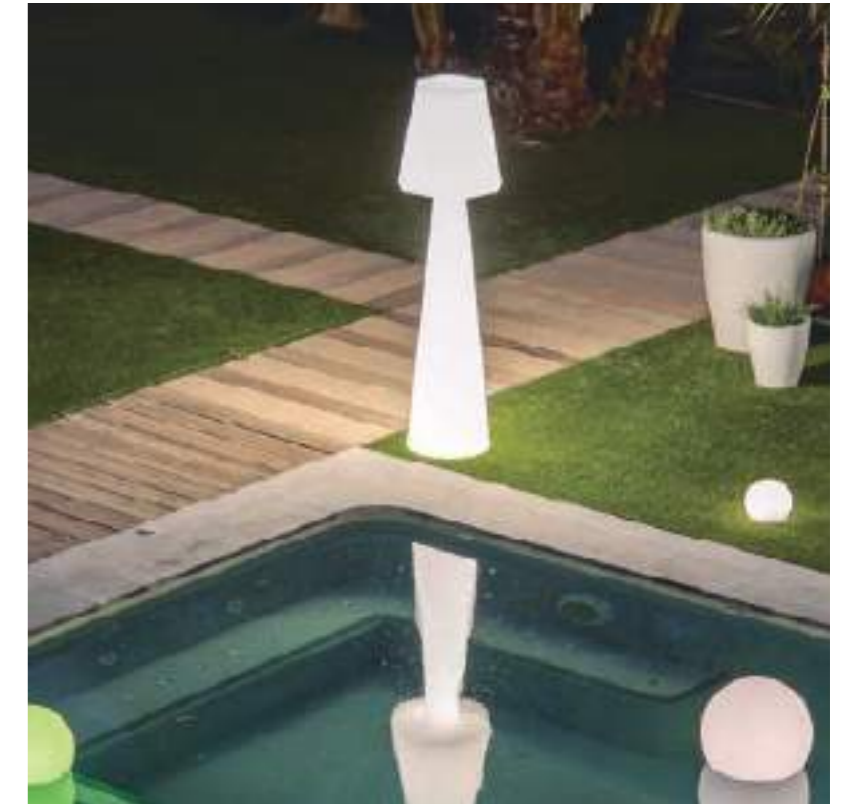

LOLA 110

# Lola 165.

## LOLA 165

### RECHARGEABLE BATTERY

REF: LUMLL165WLNW

IP65 Outdoor & Indoor use

🔋 Rechargeable Battery Electric Charge (driver not included)

☀️ White Light (included)

🌈 RGB Light (included)

lm 135 lm

📶 Remote control (included)

📶 Dimmable

💡 Led tube lighting (included)

M Polyethylene

📦 Packaging: 45,5 x 45,5 x 166 cm

📦 Gross Weight (with packaging): 11kg

### CABLE

REF: LUMLL165OFNW

IP65 Outdoor & Indoor use

☀️ White Light (included)

lm 2.200 lm

💡 Led tube lighting (included)

M Polyethylene

📦 Packaging: 45,5 x 45,5 x 166 cm

📦 Gross Weight (with packaging): 11kg

### CABLE

REF: LUMLL165OCNW

IP65 Outdoor & Indoor use

🌞 Warm Light (included)

lm 2.200 lm

💡 Led tube lighting (included)

M Polyethylene

📦 Packaging: 45,5 x 45,5 x 166 cm

📦 Gross Weight (with packaging): 11kg

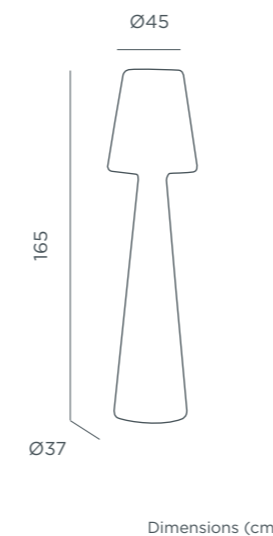

# Lola 200.

## LOLA 200

### CABLE

REF: LUMLL200OFNW

IP65 Outdoor & Indoor use

☀️ White Light (included)

lm 2.200 lm

💡 Led tube lighting (included)

M Polyethylene

📦 Packaging: 55,5 x 55,5 x 204 cm

📦 Gross Weight (with packaging): 17kg

### CABLE

REF: LUMLL200OCNW

IP65 Outdoor & Indoor use

🌞 Warm Light (included)

lm 2.200 lm

💡 Led tube lighting (included)

M Polyethylene

📦 Packaging: 55,5 x 55,5 x 204 cm

📦 Gross Weight (with packaging): 17kg

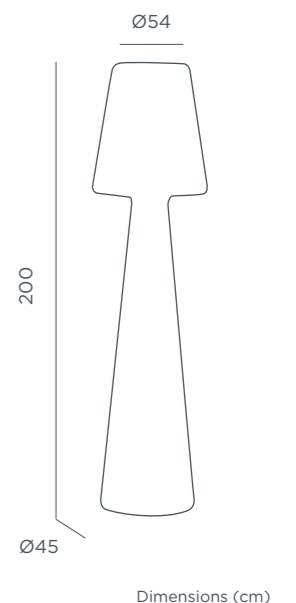



# Carmen 110.

## CARMEN 110

### RECHARGEABLE BATTERY

REF: LUMCR110WLNW

- IP65 Outdoor & Indoor use
- Rechargeable Battery Electric Charge (driver nor included)
- White Light (included)
- RGB Light (included)
- 110 lm
- Remote control (included)

- Dimmable
- Led tube lighting (included)
- M Polyethylene
- Packaging: 31,5 x 31,5 x 112,5 cm
- Gross Weight (with packaging): 4,5kg

### CABLE

REF: LUMCR110OFNW

- IP65 Outdoor & Indoor use
- White Light (included)
- 1.600 lm
- Led tube lighting (included)

- M Polyethylene
- Packaging: 31,5 x 31,5 x 112,5 cm
- Gross Weight (with packaging): 4,5kg

### CABLE

REF: LUMCR110OCNW

- IP65 Outdoor & Indoor use
- Warm Light (included)
- 1.600 lm
- Led tube lighting (included)

- M Polyethylene
- Packaging: 31,5 x 31,5 x 112,5 cm
- Gross Weight (with packaging): 4,5kg

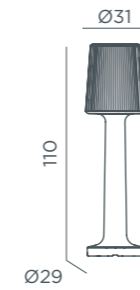

Dimensions (cm)

# Carmen 165.

## CARMEN 165

### RECHARGEABLE BATTERY

REF: LUMCR165WLNW

- IP65 Outdoor & Indoor use
- Rechargeable Battery Electric Charge (driver nor included)
- White Light (included)
- RGB Light (included)
- 135 lm
- Remote control (included)

- Dimmable
- Led tube lighting (included)
- M Polyethylene
- Packaging: 46,4 x 46,4 x 165,5 cm
- Gross Weight (with packaging): 9,5kg

### CABLE

REF: LUMCR165OFNW

- IP65 Outdoor & Indoor use
- White Light (included)
- 2.200 lm
- Led tube lighting (included)

- M Polyethylene
- Packaging: 46,4 x 46,4 x 165,5 cm
- Gross Weight (with packaging): 9,5kg

### CABLE

REF: LUMCR165OCNW

- IP65 Outdoor & Indoor use
- Warm Light (included)
- 2.200 lm
- Led tube lighting (included)

- M Polyethylene
- Packaging: 46,4 x 46,4 x 165,5 cm
- Gross Weight (with packaging): 9,5kg

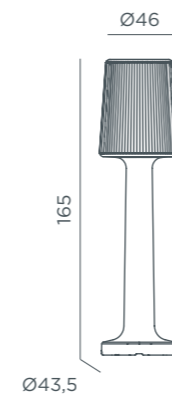

Dimensions (cm)





# Fredo.

## FREDO 140

### RECHARGEABLE BATTERY

REF: LUMFD140TWLNW

- IP65 Outdoor & Indoor use
- Rechargeable Battery Electric Charge (driver nor included)
- White Light (included)
- RGB Light (included)
- 115 lm
- Remote control (included)

- Dimmable
- Led tube lighting (included)
- M Polyethylene
- Packaging: 39 x 39 x 140 cm
- Gross Weight (with packaging): 6kg

### CABLE

REF: LUMFD140OFNW

- IP65 Outdoor & Indoor use
- White Light (included)
- 1800 lm
- Led tube lighting (included)

- M Polyethylene
- Packaging: 39 x 39 x 140 cm
- Gross Weight (with packaging): 6kg

### CABLE

REF: LUMFD140OCNW

- IP65 Outdoor & Indoor use
- Warm Light (included)
- 1800 lm
- Led tube lighting (included)

- M Polyethylene
- Packaging: 39 x 39 x 140 cm
- Gross Weight (with packaging): 6kg

## FREDO 170

### RECHARGEABLE BATTERY

REF: LUMFD170WLNW

- IP54 Outdoor & Indoor use
- Rechargeable Battery Electric Charge (driver nor included)
- White Light (included)
- RGB Light (included)
- 135 lm
- Remote control (included)

- Dimmable
- Led tube lighting (included)
- M Polyethylene
- Packaging: 48 x 48 x 170 cm
- Gross Weight (with packaging): 8,5kg

### CABLE

REF: LUMFD170OFNW

- IP65 Outdoor & Indoor use
- White Light (included)
- 2.200 lm
- Led tube lighting (included)

- M Polyethylene
- Packaging: 48 x 48 x 170 cm
- Gross Weight (with packaging): 8,5kg

### CABLE

REF: LUMFD170OCNW

- IP65 Outdoor & Indoor use
- Warm Light (included)
- 2.200 lm
- Led tube lighting (included)

- M Polyethylene
- Packaging: 48 x 48 x 170 cm
- Gross Weight (with packaging): 8,5kg

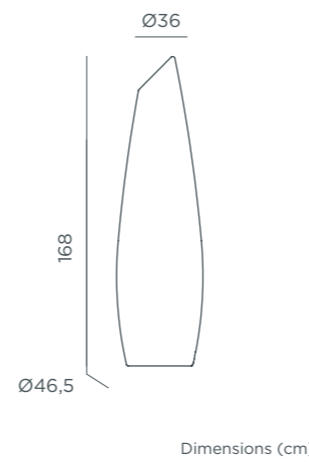
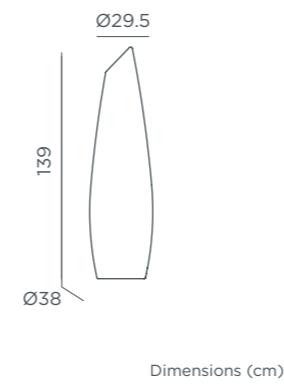



# Konika.



## KONIKA 170

### RECHARGEABLE BATTERY

REF: LUMKN170WLNW

- IP65 Outdoor & Indoor use
- Rechargeable Battery Electric Charge (driver not included)
- White Light (included)
- RGB Light (included)
- 135 lm
- Remote control (included)

- Dimmable
- Led tube lighting (included)
- M Polyethylene
- Packaging: 45,8 x 45,8 x 171 cm
- Gross Weight (with packaging): 10,3kg



Dimensions (cm)

### CABLE

REF: LUMKN170OFNW

- IP65 Outdoor & Indoor use
- White Light (included)
- 2.200 lm
- Led tube lighting (included)

- M Polyethylene
- Packaging: 45,8 x 45,8 x 171 cm
- Gross Weight (with packaging): 10,3kg



# Grace 140.

## GRACE 140

### RECHARGEABLE BATTERY

REF: LUMGC140WLNW

- IP54 Outdoor & Indoor use
- Rechargeable Battery Electric Charge (driver nor included)
- White Light (included)
- RGB Light (included)
- 115 lm
- Remote control (included)

- Dimmable
- Led tube lighting (included)
- M Polyethylene
- Packaging: 38 x 38 x 138 cm
- Gross Weight (with packaging): 6,5kg

### CABLE

REF: LUMGC140OFNW

- IP65 Outdoor & Indoor use
- White Light (included)
- 1.800 lm
- Led tube lighting (included)

- M Polyethylene
- Packaging: 38 x 38 x 138 cm
- Gross Weight (with packaging): 6,5kg

### CABLE

REF: LUMGC140OCNW

- IP65 Outdoor & Indoor use
- Warm Light (included)
- 1.800 lm
- Led tube lighting (included)

- M Polyethylene
- Packaging: 38 x 38 x 138 cm
- Gross Weight (with packaging): 6,5kg



Dimensions (cm)

# Grace 170.

## GRACE 170

### RECHARGEABLE BATTERY

REF: LUMGC170WLNW

- IP65 Outdoor & Indoor use
- Rechargeable Battery Electric Charge (driver nor included)
- White Light (included)
- RGB Light (included)
- 135 lm
- Remote control (included)

- Dimmable
- Led tube lighting (included)
- M Polyethylene
- Packaging: 46 x 46 x 170 cm
- Gross Weight (with packaging): 8,5kg

### CABLE

REF: LUMGC170OFNW

- IP65 Outdoor & Indoor use
- White Light (included)
- 2.200 lm
- Led tube lighting (included)

- M Polyethylene
- Packaging: 46 x 46 x 170 cm
- Gross Weight (with packaging): 8,5kg

### CABLE

REF: LUMGC170OCNW

- IP65 Outdoor & Indoor use
- Warm Light (included)
- 2.200 lm
- Led tube lighting (included)

- M Polyethylene
- Packaging: 46 x 46 x 170 cm
- Gross Weight (with packaging): 8,5kg

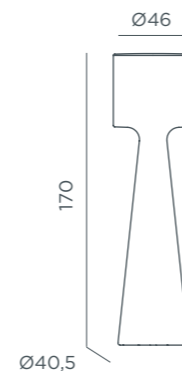

Dimensions (cm)





# Kaktus.



## KAKTUS 100

### RECHARGEABLE BATTERY

White |  REF: LUMKL100TDLNW

- Outdoor & Indoor use
- Rechargeable Battery Electric Charge (driver not included)
- White Light (included)
- RGB Light (included)
- 110 lm
- Remote control (included)

- Dimmable
- Led tube lighting (included)
- Polyethylene
- Packaging: 34,2 x 34,2 x 101 cm
- Gross Weight (with packaging): 3,7kg

### CABLE

- Outdoor & Indoor use
- White Light (included)
- 1.400 lm
- Led tube lighting (included)
- Polyethylene
- Packaging: 34,2 x 34,2 x 101 cm
- Gross Weight (with packaging): 4,1kg

White |  REF: LUMKL100DFNW  
Lime |  REF: LUMKL100DFNW

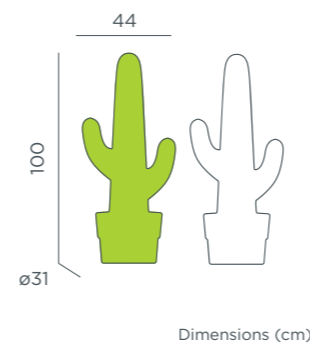



# Okinawa Lantern.



Light & Deco | Decorative | Okinawa Lantern

## OKINAWA LANTERN | NATURE COLLECTION

SOLAR & RECHARGEABLE BATTERY

REF: LUMOKLO24XXSLNW

- IP54 Outdoor & Indoor use
- Solar + Rechargeable Battery (driver not included)
- Warm Light (included)
- 900 lm
- Remote control (included)
- Dimmable

- Rechargeable bulb Cherry (included)
- Solar panel included
- Bamboo | Metal Handle (anthracite colour)
- Packaging: 16 x16 x 25,5 cm
- Gross Weight (with packaging): 1,3kg

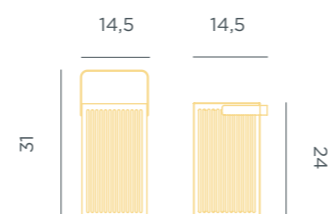

Dimensions (cm)





# Siroco 30.

## SIROCO 30

### RECHARGEABLE BATTERY

- IP54 Outdoor & Indoor use
- 🔋 Rechargeable Battery Electric Charge (driver not included)
- 💡 Warm Light Mode
- 🔥 Flame effect led light Mode
- lm 200 lm
- 📡 Remote control (included)

REF: LUMSRC030BXWLNW

- 📏 Dimmable
- 🕯️ Candy lamp (included)
- 🔩 Lacquered Iron (black colour)
- 📦 Packaging: 31,3 x 19 x 19 cm
- 📦 Gross Weight (with packaging): 1,9kg

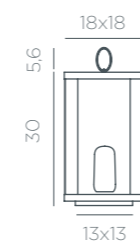

Dimensions (cm)

# Siroco 50.

## SIROCO 50

### RECHARGEABLE BATTERY

- IP54 Outdoor & Indoor use
- 🔋 Rechargeable Battery Electric Charge (driver not included)
- 💡 Warm Light Mode
- 🔥 Flame effect led light Mode
- lm 200 lm
- 📡 Remote control (included)

REF: LUMSRC050BXWLNW

- 📏 Dimmable
- 🕯️ Candy lamp (included)
- 🔩 Lacquered Iron (black colour)
- 📦 Packaging: 51,3 x 19 x 19 cm
- 📦 Gross Weight (with packaging): 2,5kg



Dimensions (cm)





# Hiama.



## HIAMA | NATURE COLLECTION

### SOLAR

- IP44 Outdoor use
- Solar Battery
- Flame effect led light
- lm 25 lm
- Twilight sensor

REF: LUMHIA120XXSLNW

- Integrated solar panel
- M Bamboo
- Box Packaging: 122 x 52 x 19 cm
- Gross Weight: 0,19kg per unit

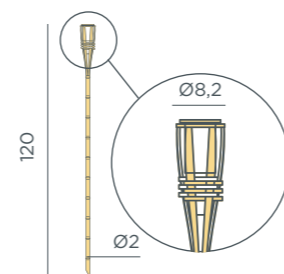

Dimensions (cm)





# Greta.

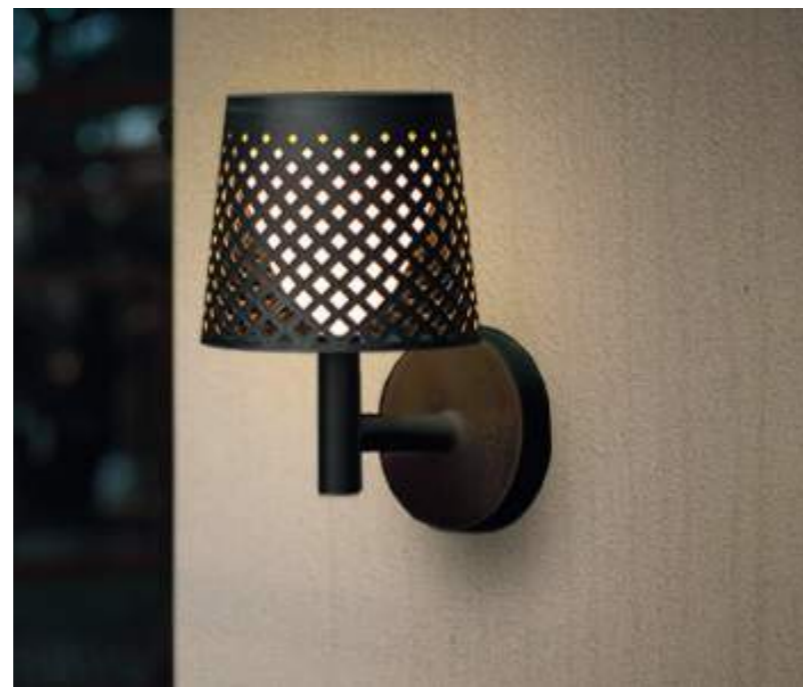

## GRETA

SOLAR & RECHARGEABLE BATTERY

- IP65 Outdoor & Indoor use
- Solar + Rechargeable Battery (driver not included)
- Warm Light (included)
- 100 lm
- Twilight sensor
- Touch control
- Recycled Plastic
- Packaging: 23,5 x 22 x 16,5 cm
- Gross Weight (with packaging): 0,7kg

White | REF: LUMGRE080BXSNNW  
 Black | REF: LUMGRE080NXSNNW

5 lamps in 1

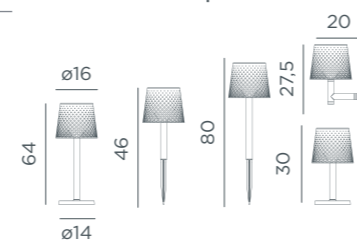

Dimensions (cm)



MADE OF RECYCLED MATERIALS



# Gretita.



MADE OF RECYCLED MATERIALS

Light & Deco | Functionals | Gretita

## GRETITA

### SOLAR

- IP44 Outdoor use
- Solar Battery
- Warm Light (included)
- lm 4 lm
- Twilight sensor
- Integrated solar panel
- M Recycled Plastic
- Packaging: 10 x 37 x 12 cm
- Gross Weight (with packaging): 0,6kg

White | ○ REF: LUMGRT039BXSLNW  
Black | ● REF: LUMGRT039NXSLNW





# Gretita Table Lamp.



# Solar Gretita Table Lamp.



## GRETITA TABLE LAMP

### AAA BATERIES

- IP44 Outdoor & Indoor use
- 3 AAA batteries(not included)
- Warm Light (included)
- 80 lm
- Touch control
- Dimmable
- Recycled Plastic
- Packaging: 14,2 x 12 x 17,6 cm
- Gross Weight (with packaging): 0,3kg

White | ○ REF: LUMGRT030BXWLNW  
 Anthracite | ● REF: LUMGRT030ANWLNW

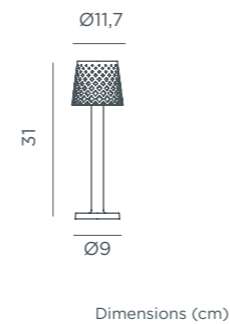

Dimensions (cm)

## SOLAR GRETITA TABLE LAMP

### SOLAR & RECHARGEABLE BATTERY

- IP44 Outdoor & Indoor use
- Solar + Rechargeable Battery (driver not included)
- Warm Light (included)
- 100 lm
- Dimmable

Black | ● REF: LUMGTS030NXSWNW

- Solar panel included
- Twilight sensor
- Metal | PET
- Packaging: 12,5 x 13,5 x 11,5 cm
- Gross Weight (with packaging): 0,76kg

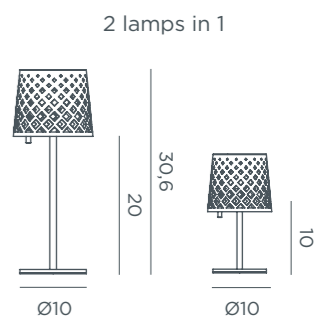

Dimensions (cm)



# Conta.



MADE OF RECYCLED MATERIALS

CONTA 70



CONTA 30



## CONTA 30

### RECHARGEABLE BATTERY

IP54 Outdoor & Indoor use

Rechargeable Battery Electric Charge (driver not included)

Warm Light (included)

lm 900 lm

Remote control (included)

Taupe grey | ● REF: LUMCNT030SXWLNW

Dimmable

Rechargeable bulb Cherry (included)

Recycled Plastic

Packaging: 27 x 27 x 40 cm

Gross Weight (with packaging): 1,3kg

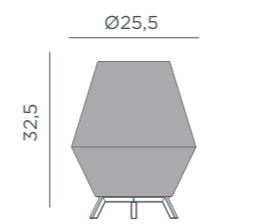

Dimensions (cm)

## CONTA 70

### RECHARGEABLE BATTERY

IP54 Outdoor & Indoor use

Rechargeable Battery Electric Charge (driver not included)

Warm Light (included)

lm 900 lm

Remote control (included)

Taupe grey | ● REF: LUMCNT070SXWLNW

Dimmable

Rechargeable bulb Cherry (included)

Recycled Plastic

Packaging: 50,4 x 50,4 x 74 cm

Gross Weight (with packaging): 4,3kg

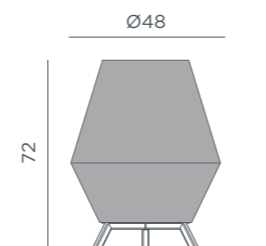

Dimensions (cm)





# Saona.

SAONA 30



SAONA 70 | 30



## SAONA 30 | NATURE COLLECTION

### RECHARGEABLE BATTERY

- IP54 Outdoor & Indoor use
- Rechargeable Battery Electric Charge (driver not included)
- Warm Light (included)
- lm 900 lm
- Remote control (included)

REF: LUMSAO030XXWLNW

- Dimmable
- Rechargeable bulb Cherry (included)
- Rattan
- Packaging: 27 x 27 x 40 cm
- Gross Weight (with packaging): 1,46kg

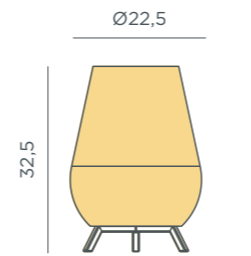

Dimensions (cm)

## SAONA 70 | NATURE COLLECTION

### RECHARGEABLE BATTERY

- IP54 Outdoor & Indoor use
- Rechargeable Battery Electric Charge (driver not included)
- Warm Light (included)
- lm 900 lm
- Remote control (included)

REF: LUMSAO070XXWLNW

- Dimmable
- Rechargeable bulb Cherry (included)
- Rattan
- Packaging: 50,4 x 50,4 x 74 cm
- Gross Weight (with packaging): 3,34kg

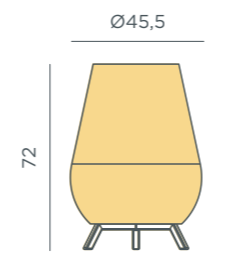

Dimensions (cm)

### JUTE CABLE

- IP65 Outdoor & Indoor use
- Warm Light (included)
- White Light (included)
- lm 460 lm
- Remote control (included)

REF: LUMSAO070XXIONW

- Dimmable
- Rattan
- Packaging: 50,4 x 50,4 x 74 cm
- Gross Weight (with packaging): 3,88kg





# Sisine.

SISINE 30



SISINE 70



## SISINE 30 | NATURE COLLECTION

### RECHARGEABLE BATTERY

- IP54 Outdoor & Indoor use
- Rechargeable Battery Electric Charge (driver not included)
- Warm Light (included)
- 900 lm
- Remote control (included)

REF: LUMSIS030XXWLNW

- Dimmable
- Rechargeable bulb Cherry (included)
- Rattan
- Packaging: 27 x 27 x 40 cm
- Gross Weight (with packaging): 1,37kg

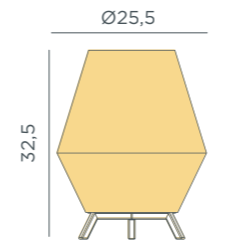

Dimensions (cm)

## SISINE 70 | NATURE COLLECTION

### RECHARGEABLE BATTERY

- IP54 Outdoor & Indoor use
- Rechargeable Battery Electric Charge (driver not included)
- Warm Light (included)
- 900 lm
- Remote control (included)

REF: LUMSAO070XXWLNW

- Dimmable
- Rechargeable bulb Cherry (included)
- Rattan
- Packaging: 50,4 x 50,4 x 74 cm
- Gross Weight (with packaging): 3,34kg

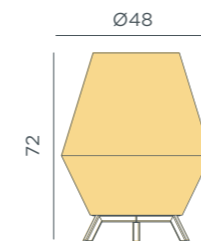

Dimensions (cm)

### JUTE CABLE

- IP65 Outdoor & Indoor use
- Warm Light (included)
- White Light (included)
- 460 lm
- Remote control (included)

REF: LUMSAO070XXIONW

- Dimmable
- Rattan
- Packaging: 50,4 x 50,4 x 74 cm
- Gross Weight (with packaging): 3,8kg





# Bossa 30.



## BOSSA 30 | NATURE COLLECTION

### RECHARGEABLE BATTERY

- IP54 Outdoor & Indoor use
- Rechargeable Battery Electric Charge (driver not included)
- Warm Light (included)
- 900 lm
- Remote control (included)

REF: LUMBOS030XXWLNW

- Dimmable
- Rechargeable bulb Cherry (included)
- Rattan
- Packaging: 27 x 27 x 40 cm
- Gross Weight (with packaging): 1,2kg

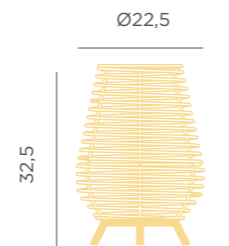

Dimensions (cm)

# Okinawa Table Lamp.



## OKINAWA TABLE LAMP | NATURE COLLECTION

### SOLAR & RECHARGEABLE BATTERY

- IP54 Outdoor & Indoor use
- Solar + Rechargeable Battery (driver not included)
- Warm Light (included)
- 350 lm
- Remote control (included)
- Dimmable

REF: LUMOKT036NWSWNW

- Rechargeable bulb Mini Cherry (included)
- Solar panel included
- Bamboo | Metal (black colour)
- Packaging: 16,5 x 16,5 x 12 cm
- Gross Weight (with packaging): 0,9kg

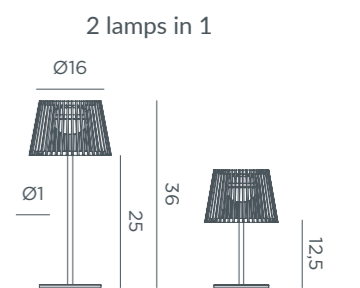

Dimensions (cm)



# Chloe 35.



## CHLOE 35

### SOLAR & RECHARGEABLE BATTERY

REF: LUMCHL035SSNW

- IP65 Outdoor & Indoor use
- Rechargeable Battery Electric Charge (driver not included)
- White Light (included)
- RGB Light (included)
- lm 45 lm
- Remote control (included)

- Dimmable
- Twilight sensor
- Beechwood | Polyethylene
- Packaging: 28,3 x 28,3 x 18 cm
- Gross Weight (with packaging): 1,8kg

### JUTE CABLE

REF: LUMCHL035CCNW

- IP44 Outdoor & Indoor use
- Warm Light (included)
- lm 500 lm
- Dimmable

- Touch control
- Beechwood
- Packaging: 28,3 x 28,3 x 18 cm
- Gross Weight (with packaging): 1,8kg

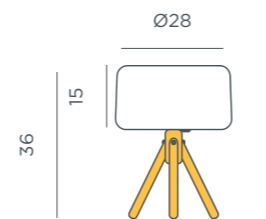

Dimensions (cm)

# Jack Lux.



## JACK 10 LUX

### RECHARGEABLE BATTERY

REF: LUMJCK010XXWLNW

- IP54 Indoor & outdoor use
- Rechargeable Battery Electric Charge (driver not included)
- Warm Light Mode
- Flame effect led light Mode

- lm 100 lm lamp mode | 20 lm candle mode
- PS
- Packaging: 31 x 40 x 12,8 cm
- Gross Weight (with packaging): 0,228kg

## JACK 20 LUX

### RECHARGEABLE BATTERY

REF: LUMJCK020XXWLNW

- IP54 Indoor & outdoor use
- Rechargeable Battery Electric Charge (driver not included)
- Warm Light Mode
- Flame effect led light Mode

- lm 100 lm lamp mode | 20 lm candle mode
- PS
- Packaging: 31,8x 41,5 x 23,5 cm
- Gross Weight (with packaging): 0,342kg

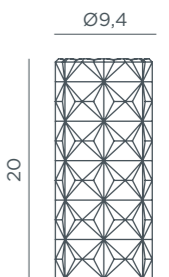
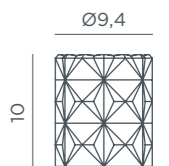

Dimensions (cm)



# Lola 12 Lux.



## LOLA 12 LUX

REPLACEABLE BATTERY

REF: LUMLOLO12XXAANW

- IP44 Outdoor & Indoor use
- Replaceable battery (Battery CR2032 included)
- Warm Light (included)

- M PP
- Packaging:  $\varnothing 6,6 \times 12$  cm
- Gross Weight (with packaging): 0,08kg



Dimensions (cm)

# Lola 20 Lux.



## LOLA 20 LUX

RECHARGEABLE BATTERY

REF: LUMLOLO20XXWLNW

- IP44 Outdoor & Indoor use
- Rechargeable Battery Electric Charge (driver not included)
- Warm Light (included)
- lm 120 lm

- Touch control
- M PMMA
- Packaging: 13,5 x 24,5 x 13,5 cm
- Gross Weight (with packaging): 0,67kg



Dimensions (cm)



# Shitake.



## SHITAKE

### RECHARGEABLE BATTERY

- IP44 Outdoor & Indoor use
- Rechargeable Battery Electric Charge (driver not included)
- Warm Light (included)
- lm 450 lm
- Touch control
- M ABS
- Packaging: 18,5 x 17 x 26 cm
- Gross Weight (with packaging): 1,03kg

- White | ○ REF: LUMSTK025BXWLNW
- Black | ● REF: LUMSTK025NXWLNW

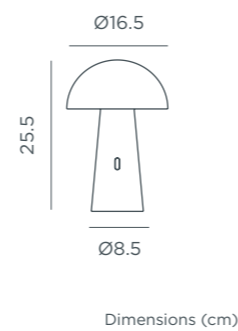

# Maia.



## MAIA

### RECHARGEABLE BATTERY

- IP44 Outdoor & Indoor use
- Rechargeable Battery Electric Charge (driver not included)
- Warm Light (included)
- White Light (included)
- RGB Light (included)
- lm 100 lm
- Led tube lighting (included)
- M ABS
- Packaging: 9,7 x 9,7 x 20,3 cm
- Gross Weight (with packaging): 0,4kg

- Brass | ● REF: LUMMAI019BRWLNW
- Space grey | ● REF: LUMMAI019GEWLNW

Multi Magnetic Charging Base  
(Accessory not included)

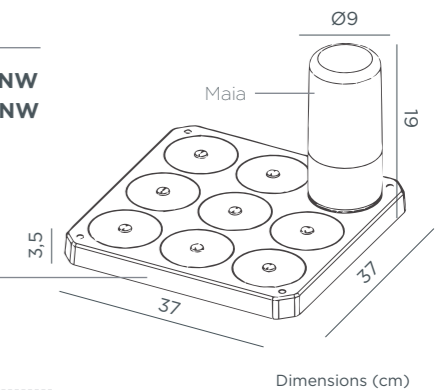

Accessory: Multi Magnetic Charging Base (x9 charging points)

REF: ACCBDC009NXNLNW

- Rechargeable Battery Electric Charge



# Sardinia.

SARDINIA 40



SARDINIA 30



## SARDINIA 30

### RECHARGEABLE BATTERY

- IP44 Outdoor & Indoor use
- Rechargeable Battery Electric Charge (driver not included)
- Warm Light (included)
- lm 400 lm
- Touch control
- M Lacquered Iron
- Packaging: 28 x 18,5 x 4,5 cm
- Gross Weight (with packaging): 0,7kg

- White | ○ REF: LUMSDN030BXWLNW
- Antracite | ● REF: LUMSDN030ANWLNW

2 lamps in 1

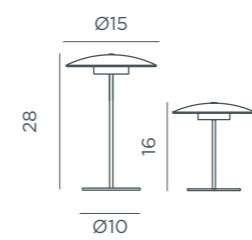

Dimensions (cm)

## SARDINIA 40

### RECHARGEABLE BATTERY

- IP44 Outdoor & Indoor use
- Rechargeable Battery Electric Charge (driver not included)
- Warm Light (included)
- lm 700 lm
- Touch control
- M Lacquered Iron
- Packaging: 24 x 40,5 x 5,5 cm
- Gross Weight (with packaging): 1,4kg

- White | ○ REF: LUMSDN040BXWLNW
- Antracite | ● REF: LUMSDN040ANWLNW



Dimensions (cm)





# Candy.



## CANDY

### RECHARGEABLE BATTERY

IP54 Indoor & outdoor use

Rechargeable Battery Electric Charge (driver not included)

Warm Light Mode

Flame effect led light Mode

200 lm

Remote control (included)

Dimmable

Magnetic surface

Recycled Plastic

Packaging: 20,5 x 9,2 x 9,2 cm

Gross Weight (with packaging): 0,32kg

REF: LUMCND019BXWLNW

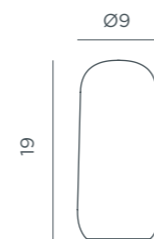

Dimensions (cm)



MADE OF RECYCLED MATERIALS





# Norai Slim 35.



## NORAI SLIM 35

### RECHARGEABLE BATTERY

- IP44 Outdoor & Indoor use
- Rechargeable Battery Electric Charge (driver not included)
- Warm Light (included)
- lm 160 lm
- Dimmable
- Touch control
- ABS | Metal
- Packaging: 11,7 x 11,7 x 36 cm
- Gross Weight (with packaging): 0,6kg

- Anthracite | ● REF: LUMNRS035ANWLNW
- Brass | ● REF: LUMNRS035BRWLNW
- Rose gold | ● REF: LUMNRS035RGWLNW
- Space grey | ● REF: LUMNRS035GEWLNW
- White | ○ REF: LUMNRS035BXWLNW

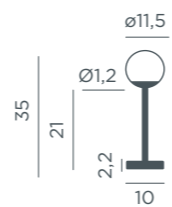

Dimensions (cm)



# Lola Slim 30.



## LOLA SLIM 30

### RECHARGEABLE BATTERY

- IP44 Outdoor & Indoor use
- Rechargeable Battery Electric Charge (driver not included)
- Warm Light (included)
- lm 260 lm
- Dimmable
- Touch control
- PP Difusor | Metal
- Packaging: 11,7 x 11,7 x 38 cm
- Gross Weight (with packaging): 0,47kg

- Anthracite | ● REF: LUMLLS030ANWLNW
- Mint | ● REF: LUMLLS030MNWLNW
- Brass | ● REF: LUMLLS030BRWLNW
- Rose gold | ● REF: LUMLLS030RGWLNW
- Space grey | ● REF: LUMLLS030GEWLNW
- Lime | ● REF: LUMLLS030LIWLNW
- White | ○ REF: LUMLLS030BXWLNW

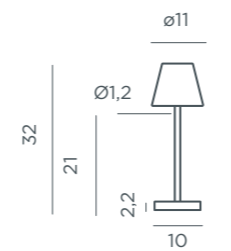

Dimensions (cm)



# Rocket 20.



## ROCKET 20

### RECHARGEABLE BATTERY

- IP43 Outdoor & Indoor use
- Rechargeable Battery Electric Charge (driver not included)
- Warm Light (included)
- 11 lm
- Touch control

REF: LUMRCK20WLNW

- Dimmable
- M Silicone | Wood
- Packaging: 13,5 x 13,5 x 14,5 cm
- Gross Weight (with packaging): 0,35kg

Ø14,2



19,4

Dimensions (cm)

# Panchito.



## PANCHITO

### RECHARGEABLE BATTERY

- IP43 Outdoor & Indoor use
- Rechargeable Battery Electric Charge (driver not included)
- Warm Light (included)
- 11 lm
- Touch control
- Dimmable
- M Silicone
- Packaging: 15,6 x 10 x 21,5 cm
- Gross Weight (with packaging): 0,36kg

- White | ○ REF: LUMPCT20WVLNW
- Lime | ● REF: LUMPCT20VVLNW

16,5

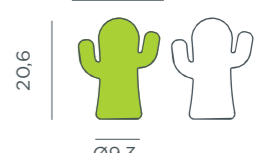

20,6

Ø9,3

Dimensions (cm)



# Lola.

## LOLA 20

### RECHARGEABLE BATTERY

REF: LUMLL020WLNW

- IP43 Outdoor & Indoor use
- Rechargeable Battery Electric Charge (driver not included)
- White Light (included)
- RGB Light (included)
- lm 18 lm

- Touch control
- M PC
- Packaging: 11,4 x 11,4 x 21,1 cm
- Gross Weight (with packaging): 0,3kg

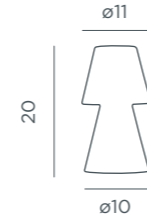

Dimensions (cm)

### AAA BATERIES

REF: LUMLL20AAAANW

- IP20 Outdoor & Indoor use
- 3 AAA Batteries (not included)
- RGB Light (included)
- lm 8 lm

- M PC
- Packaging: 11,4 x 11,4 x 21,1 cm
- Gross Weight (with packaging): 0,3kg

## LOLA 30

### RECHARGEABLE BATTERY

REF: LUMLL030WLNW

- IP54 Outdoor & Indoor use
- Rechargeable Battery Electric Charge (driver not included)
- White Light (included)
- RGB Light (included)
- lm 45 lm
- Remote control (included)

- Dimmable
- LED Led tube lighting (included)
- M Polyethylene
- Packaging: 17 x 17 x 31,6 cm
- Gross Weight (with packaging): 1,2kg



Dimensions (cm)

## LOLA 45

### RECHARGEABLE BATTERY

REF: LUMLL030WLNW

- IP65 Outdoor & Indoor use
- Rechargeable Battery Electric Charge (driver not included)
- White Light (included)
- RGB Light (included)
- lm 360 lm
- Remote control (included)

- Dimmable
- LED Led tube lighting (included)
- M Polyethylene
- Packaging: 26 x 26 x 48 cm
- Gross Weight (with packaging): 1,7kg



Dimensions (cm)

### CABLE

REF: LUMLL045OFNW

- IP65 Outdoor & Indoor use
- White Light (included)
- lm 600 lm

- M Polyethylene
- Packaging: 26 x 26 x 48 cm
- Gross Weight (with packaging): 1,7kg



LOLA 20



LOLA 30



LOLA 45



# Allegra.



## ALLEGRA

### SOLAR & RECHARGEABLE BATTERY

- IP44 Outdoor & Indoor use
- Rechargeable Battery Electric Charge (driver not included)
- Warm Light (included)
- Im 35 lm (lumens per bulb)
- Solar panel included
- M PVC
- ⊞ Packaging: 28,5 x 15 x 15 cm
- 📦 Gross Weight (with packaging): 1,32kg

- White cable | ○ REF: LUMGASBXSLNW
- Jute cable | ● REF: LUMGASXXSLNW
- Black cable | ● REF: LUMGASNXSLNW

### JUTE CABLE

- IP44 Outdoor & Indoor use
- Warm Light (included)
- Im 35 lm (lumens per bulb)
- 🔌 Connectable

- Jute cable | ● REF: LUMGASXXOCNW
- M PVC | Jute cable
- ⊞ Packaging: 28,5 x 15 x 15 cm
- 📦 Gross Weight (with packaging): 1,25kg

### CABLE (WARM LIGHT)

- IP44 Outdoor & Indoor use
- Warm Light (included)
- Im 35 lm (lumens per bulb)
- 🔌 Connectable
- M PVC
- ⊞ Packaging: 21 x 35 x 12 cm
- 📦 Gross Weight (with packaging): 0,8kg

- White cable | ○ REF: LUMGALLOCBXNW
- Pink cable | ● REF: LUMGALLOCRNW
- Black cable | ● REF: LUMGALLOCNW

### CABLE (RGB LIGHT)

- IP44 Outdoor & Indoor use
- White Light (included)
- RGB Light (included)
- Im 35 lm (lumens per bulb)
- 📱 Remote control (included)

- Black cable | ● REF: LUMGALLRGBNW
- 🔌 Connectable
- M PVC
- ⊞ Packaging: 28,5 x 15 x 12 cm
- 📦 Gross Weight (with packaging): 0,9kg

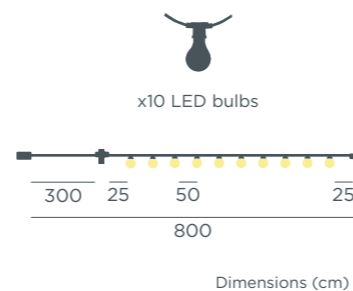



# Stella.



## STELLA

### SOLAR & RECHARGEABLE BATTERY

REF: LUMGSTLSLNW

- IP44 Outdoor & Indoor use
- Solar + Rechargeable Battery (driver not included)
- Warm Light (included)
- lm 35 lm (lumens per bulb)

- Solar panel included
- M PVC | Transparent cable
- Packaging: 15 x 20 x 15 cm
- Gross Weight (with packaging): 0,7kg

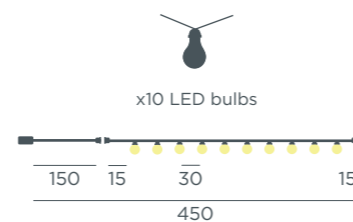

Dimensions (cm)

### CABLE

REF: LUMGSTLOCNW

- IP44 Outdoor & Indoor use
- Warm Light (included)
- lm 35 lm (lumens per bulb)
- Connectable

- M PVC | Transparent cable
- Packaging: 12 x 20 x 17 cm
- Gross Weight (with packaging): 0,4kg

# Mykonos.



## MYKONOS GARLAND

### SOLAR, RECHARGEABLE BATTERY & CABLE

REF: LUMMKN800XXSCNW

- IP44 Outdoor & Indoor use
- Solar + Rechargeable Battery (driver not included)
- Warm Light (included)
- lm 35 lumens per bulb

- Solar panel included
- M Cotton | PVC
- Packaging: 21 x 25 x 15 cm
- 0,8 kg

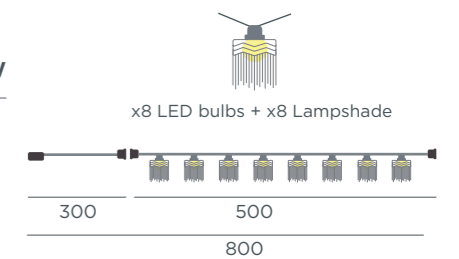

Dimensions (cm)



# Aurora.



## AURORA | NATURE COLLECTION

### SOLAR & RECHARGEABLE BATTERY

REF: LUMAUR800XXSLNW

- IP44 Outdoor & Indoor use
- Solar + Rechargeable Battery (driver not included)
- Warm Light (included)
- 35 lm (lumens per bulb)

- Solar panel included
- M** Jute
- Packaging: 15 x 35 x 21cm
- Gross Weight (with packaging): 1,4kg

### JUTE CABLE

REF: LUMAUR800XXOCNW

- IP44 Outdoor & Indoor use
- Warm Light (included)
- 35 lm (lumens per bulb)
- Connectable

- M** Jute
- Packaging: 12 x 35 x 21 cm
- Gross Weight (with packaging): 0,78kg

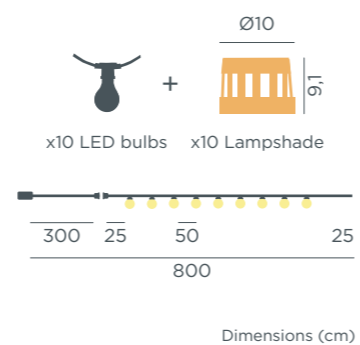

# Alba.



## ALBA | NATURE COLLECTION

### SOLAR & RECHARGEABLE BATTERY

REF: LUMALB800XXSLNW

- IP44 Outdoor & Indoor use
- Solar + Rechargeable Battery (driver not included)
- Warm Light (included)
- 35 lm (lumens per bulb)

- Solar panel included
- M** Esparto | Jute cable
- Packaging: 31 x 21,5 x 20,5 cm
- Gross Weight (with packaging): 1,22kg

### JUTE CABLE

REF: LUMALB800XXOCNW

- IP44 Outdoor & Indoor use
- Warm Light (included)
- 35 lm (lumens per bulb)
- Connectable

- M** Esparto | Jute cable
- Packaging: 31 x 21,5 x 20,5 cm
- Gross Weight (with packaging): 0,8kg

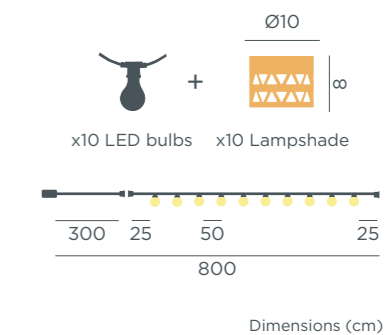



# Hياما.



FLAME EFFECT

# Okinawa.



## HIAMA GARLAND | NATURE COLLECTION

### SOLAR

- IP44 Outdoor use
- Solar battery
- Flame effect led light
- lm 2 lm (lumens per bulb)

REF: LUMHMG800XXOCNW

- Integrated solar panel
- M Bamboo | Black cable
- Packaging: 33 x 12 x 11 cm
- Gross Weight (with packaging): 0,43kg

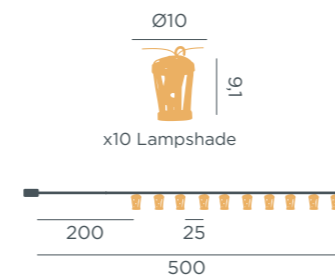

### CABLE

- IP44 Outdoor & Indoor use
- Flame effect led light
- lm 40 lm

REF: LUMHMG800XXSLNW

- M Bamboo | Black cable
- Packaging: 33 x 12 x 11 cm
- Gross Weight (with packaging): 0,41kg

Dimensions (cm)

## OKINAWA GARLAND | NATURE COLLECTION

### SOLAR & RECHARGEABLE BATTERY

- IP44 Outdoor & Indoor use
- Solar +Rechargeable Battery Electric Charge (driver not included)
- Warm Light (included)
- lm 18 lm (lumens per bulb)

REF: LUMOKG800XXSLNW

- Solar panel included
- M Bamboo | Jute cable
- Packaging: 40,5 x 16 x 10,5 cm
- Gross Weight (with packaging): 1kg

### JUTE CABLE

- IP44 Outdoor & Indoor use
- Warm Light (included)
- lm 35 lm (lumens per bulb)
- Connectable

REF: LUMOKG800XXOCNW

- M Bamboo | Jute cable
- Packaging: 40,5 x 16 x 10,5 cm
- Gross Weight (with packaging): 0,9kg

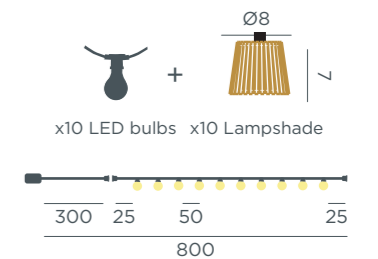

Dimensions (cm)



# Bruna.







## BRUNA

### SOLAR & RECHARGEABLE BATTERY

White cable |  REF: LUMGBR100BXS LNW



-  Outdoor & Indoor use
-  Rechargeable Battery Electric Charge (driver not included)
-  Warm Light (included)
-  50 lm (lumens per bulb)

-  Solar panel included
-  PC
-  Packaging: 15 x 28 x 38 cm
-  Gross Weight (with packaging): 2,44kg

### CABLE

White cable |  REF: LUMGBR100BROCNW

-  Outdoor & Indoor use
-  Warm Light (included)
-  50 lm (lumens per bulb)

-  PC
-  Packaging: 15 x 28 x 38 cm
-  Gross Weight (with packaging): 2,05kg

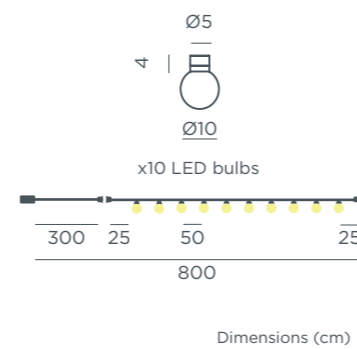



# Chelsea.



## CHELSEA

### CABLE

- IP44 Outdoor & Indoor use
- Warm Light (included)
- lm 35 lm (lumens per bulb)
- Connectable

REF: LUMCHE800BXOCNW

- M PVC | Black cable
- Packaging: 24,8 x 46,5 x 8,5cm
- Gross Weight (with packaging): 1,66kg

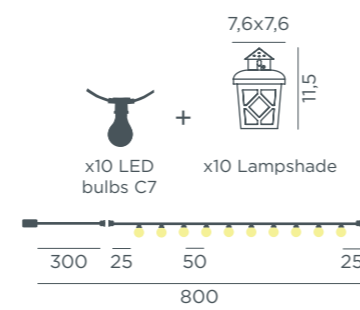

Dimensions (cm)

# Luceo.



## LUCEO 3X2

### CABLE

- IP44 Outdoor & Indoor use
- Warm Light (included)
- lm NA
- Connectable

REF: LUMLUC320XXOCNW

- M PVC | Transparent cable
- Packaging: 18 x 18 x 10 cm
- Gross Weight (with packaging): 0,71kg

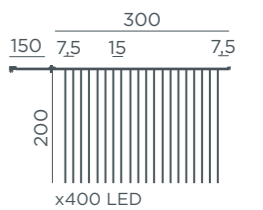

Dimensions (cm)

## LUCEO 6X3

### CABLE

- IP44 Outdoor & Indoor use
- Warm Light (included)
- lm NA

REF: LUMLUC630XXOCNW

- M PVC | Transparent cable
- Packaging: 18 x 18 x 18 cm
- Gross Weight (with packaging): 1,08kg

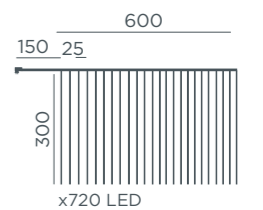

Dimensions (cm)



# Garland lift.



## GARLAND LIFT

Black | ● REF: MOBGLF250NXNW

- M Lacquered Steel
- ↔ Extendable Pole

- 📦 Packaging: 74 x 13 x 6 cm
- 📦 Gross Weight (with packaging): 3,39kg

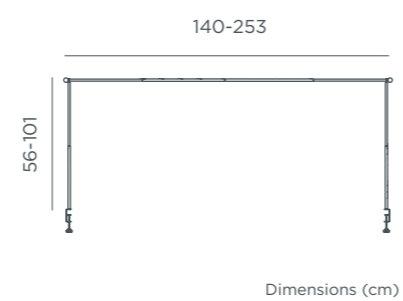



# Edy.

## EDY G125

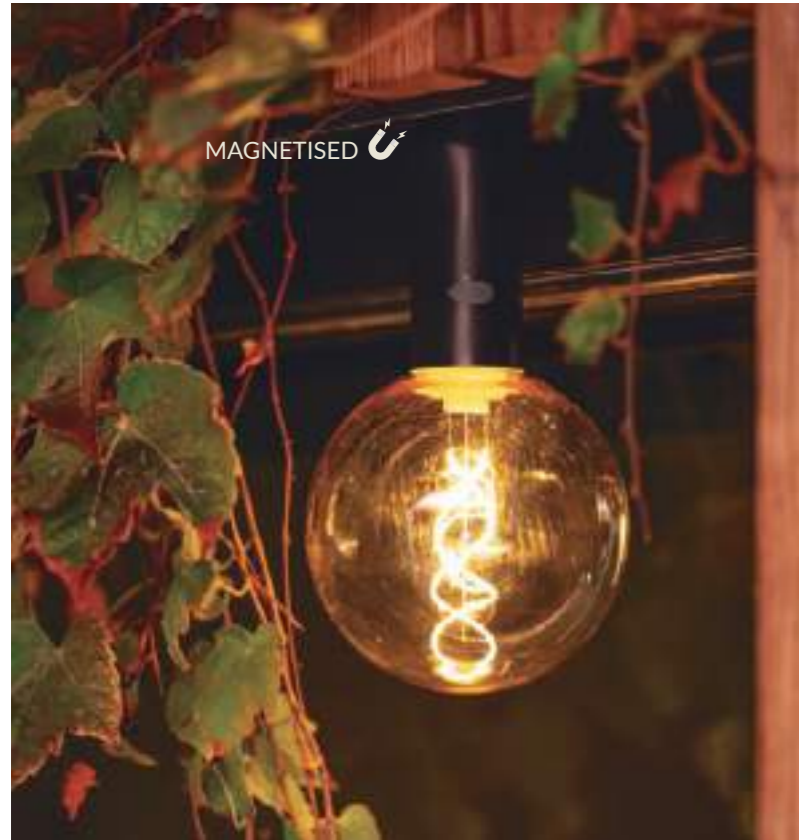

## EDY A100



### EDY A100

#### RECHARGEABLE BATTERY

- IP54 Outdoor & Indoor use
- Rechargeable Battery Electric Charge (driver not included)
- Warm Light (included)
- 200 lm
- Remote control (included)
- Dimmable

Black | ● REF: LUMEDY100NXWLNW

- Hanging product
- Magnetic surface
- Rope: 300 cm
- Recycled Plastic
- Packaging: 11,4 x 11,4 x 26 cm
- Gross Weight (with packaging): 0,5kg

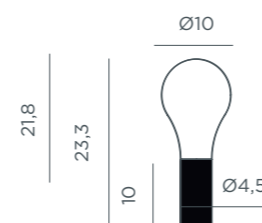

Dimensions (cm)

### EDY G125

#### RECHARGEABLE BATTERY

- IP54 Outdoor & Indoor use
- Rechargeable Battery Electric Charge (driver not included)
- Warm Light (included)
- 200 lm
- Remote control (included)
- Dimmable
- Hanging product
- Magnetic surface
- Rope: 300 cm
- Recycled Plastic
- Packaging: 13,2 x 13,2 x 23 cm
- Gross Weight (with packaging): 0,5kg

Black | ● REF: LUMEDY125NXWLNW  
 White | ○ REF: LUMEDY125BXWLNW  
 Beige | ● REF: LUMEDY125BEWLNW

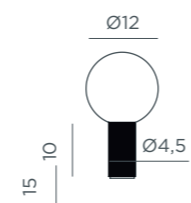

Dimensions (cm)

WITHOUT  
CABLES



MADE OF RECYCLED  
MATERIALS



# Conta Mini.



## CONTA MINI

### RECHARGEABLE BATTERY

- IP54 Outdoor & Indoor use
- 🔋 Rechargeable Battery Electric Charge (driver not included)
- 💡 Warm Light (included)
- lm 350 lm
- 📶 Remote control (included)
- 📶 Dimmable
- 🔌 Rechargeable bulb Mini Cherry (included)
- ⊕ Hanging product
- Rope: 300 cm
- M Recycled PVC
- 📦 Packaging: 16 x 16 x 16 cm
- 📦 Gross Weight (with packaging): 0.5kg

- White | ○ REF: LUMMCH015BXHWNW
- Taupe | ● REF: LUMMCH015KXHWNW
- Green | ● REF: LUMMCH015VDHWNW

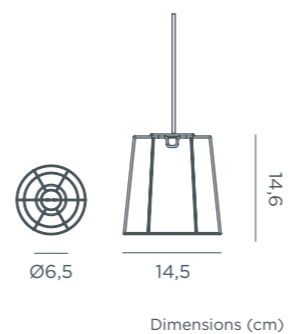

# Neo.



## NEO

### CABLE

- IP44 Outdoor & Indoor use
- 💡 Warm Light (included)
- lm 3000 lm
- 5 meters (3m light + 2m cable)

### REF: LUMNEO300BXOCNW

- LED Led tube lighting
- M Silicone
- 📦 Packaging: 26,5 X 26,5 X 7 cm
- 📦 Gross Weight (with packaging): 1.5kg

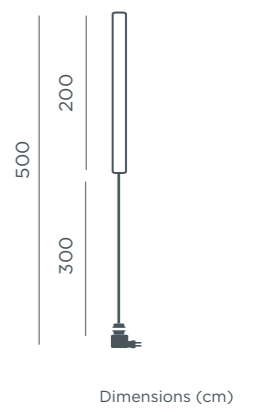



# Elba 39.

## ELBA 39

### RECHARGEABLE BATTERY

- IP54 Outdoor & Indoor use
- Rechargeable Battery Electric Charge (driver not included)
- Warm Light (included)
- 900 lm
- Remote control (included)
- Dimmable

REF: LUMELB039XXHWNW

- Rechargeable bulb Cherry included
- Hanging product
- Artificial plants included
- Polyethylene | Steel cable
- Packaging: 13 X 40,5 X 47,5 cm
- Gross Weight (with packaging): 2,8kg

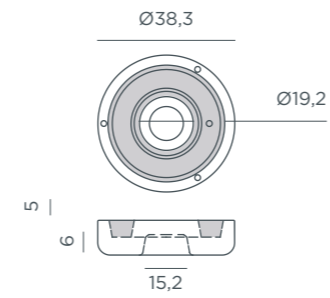

Dimensions (cm)

# Elba 59.

## ELBA 59

### RECHARGEABLE BATTERY

- IP54 Outdoor & Indoor use
- Rechargeable Battery Electric Charge (driver not included)
- Warm Light (included)
- 900 lm
- Remote control (included)
- Dimmable

REF: LUMELB059XXHWNW

- Rechargeable bulb Cherry included
- Hanging product
- Artificial plants included
- Polyethylene | Steel cable
- Packaging: 60,5 x 60,5 x 16,6 cm
- Gross Weight (with packaging): 4,8kg

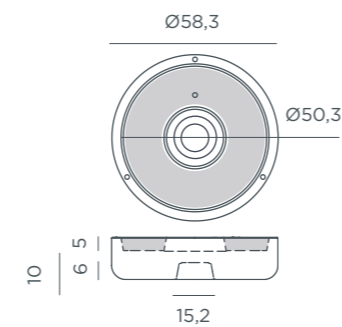

Dimensions (cm)











# Mykonos.









## MYKONOS HANG

### RECHARGEABLE BATTERY

-  IP54 Outdoor & Indoor use
-  Rechargeable Battery Electric Charge (driver not included)
-  Warm Light (included)
-  900 lm
-  Remote control (included)
-  Dimmable

White |  REF: LUMMKNO40XXWLNW

-  Rechargeable bulb Cherry included
-  Hanging product
-  Rope: 300 cm
-  Cotton
-  Packaging: 32 x 32 x 12 cm
-  Gross Weight (with packaging): 1kg

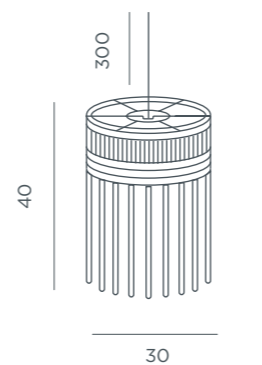

Dimensions (cm)





# Conta.



# Positano.



## CONTA HANG

### 🔋 RECHARGEABLE BATTERY

Taupe grey | ● REF: LUMCNT030SXHWNW

- IP54 Outdoor & Indoor use
- 🔋 Rechargeable Battery Electric Charge (driver not included)
- 💡 Warm Light (included)
- lm 900 lm
- 📶 Remote control (included)
- 📶 Dimmable

- 🔌 Rechargeable bulb Cherry (included)
- 🌀 Hanging product
- Rope: 300cm
- M Recycled Plastic
- 📦 Packaging: 45,2 x 44,5 x 33 cm
- 📦 Gross Weight (with packaging): 2,14kg

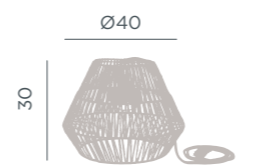

Dimensions (cm)

## POSITANO | NATURE COLLECTION

### 🔋 RECHARGEABLE BATTERY

REF: LUMPOS035XXHXNW

- IP54 Outdoor & Indoor use
- 🔋 Rechargeable Battery Electric Charge (driver not included)
- 💡 Warm Light (included)
- lm 900 lm
- 📶 Remote control (included)
- 📶 Dimmable

- 🔌 Rechargeable bulb Cherry (included)
- 🌀 Hanging product
- Rope: 300cm
- M Seagrass
- 📦 Packaging: 34,4 x 34,4 x 38,1 cm
- 📦 Gross Weight (with packaging): 1,34kg

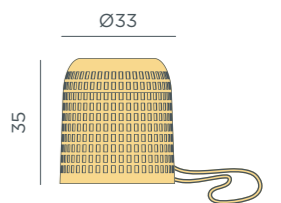

Dimensions (cm)





# Okinawa.

## OKINAWA HANG | NATURE COLLECTION

### RECHARGEABLE BATTERY

- IP54 Outdoor & Indoor use
- Rechargeable Battery Electric Charge (driver not included)
- Warm Light (included)
- 900 lm
- Remote control (included)
- Dimmable

REF: LUMOKH040XXHWNW

- Rechargeable bulb Cherry (included)
- Hanging product
- Rope: 300cm
- Bamboo
- Packaging: 39.6 X 39.6 X 31.2 cm
- Gross Weight (with packaging): 2.6kg

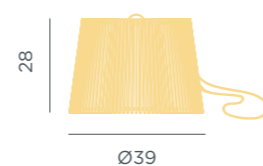

Dimensions (cm)

WITHOUT  
CABLES





# Bossa.



# Sisine.



## BOSSA HANG | NATURE COLLECTION

### RECHARGEABLE BATTERY

REF: LUMBOHXNW

- IP54 Outdoor & Indoor use
- Rechargeable Battery Electric Charge (driver not included)
- Warm Light (included)
- 900 lm
- Remote control (included)
- Dimmable

- Rechargeable bulb Cherry (included)
- Hanging product
- Rope: 300cm
- Rattan
- Packaging: 38,4 x 38,4 x 23 cm
- Gross Weight (with packaging): 1,5kg

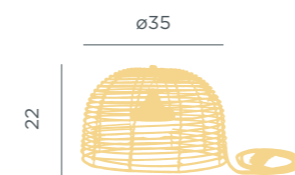

Dimensions (cm)

## SISNE HANG | NATURE COLLECTION

### RECHARGEABLE BATTERY

REF: LUMSIHXNW

- IP54 Outdoor & Indoor use
- Rechargeable Battery Electric Charge (driver not included)
- Warm Light (included)
- 900 lm
- Remote control (included)
- Dimmable

- Rechargeable bulb Cherry (included)
- Hanging product
- Rope: 300cm
- Seagrass
- Packaging: 45,2 x 44,5 x 33 cm
- Gross Weight (with packaging): 1,8kg



Dimensions (cm)



# Calobra.



# Reona.



## CALOBRA HANG | NATURE COLLECTION

### RECHARGEABLE BATTERY

- IP54 Outdoor & Indoor use
- Rechargeable Battery Electric Charge (driver not included)
- Warm Light (included)
- lm 900 lm
- Remote control (included)
- Dimmable

REF: LUMCAHXNW

- Rechargeable bulb Cherry (included)
- Hanging product
- Rope: 300cm
- M Rattan
- Packaging: 38,4 x 38,4 x 19,8 cm
- Gross Weight (with packaging): 1,4kg

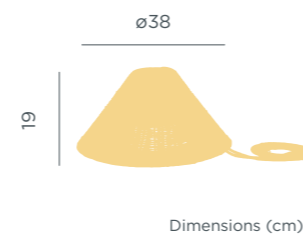

## REONA | NATURE COLLECTION

### RECHARGEABLE BATTERY

- IP54 Outdoor & Indoor use
- Rechargeable Battery Electric Charge (driver not included)
- Warm Light (included)
- lm 900 lm
- Remote control (included)
- Dimmable

REF: LUMREHXNW

- Rechargeable bulb Cherry (included)
- Hanging product
- Rope: 300cm
- M Bamboo
- Packaging: 44,5 x 45,2 x 33 cm
- Gross Weight (with packaging): 1,7kg

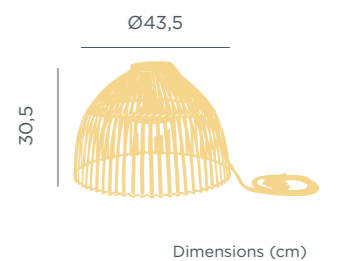



# Benirrás.



WITHOUT  
CABLES

## BENIRRÁS | NATURE COLLECTION

### RECHARGEABLE BATTERY

REF: LUMBEN035XXHXNW

- IP54 Outdoor & Indoor use
- Rechargeable Battery Electric Charge (driver not included)
- Warm Light (included)
- lm 900 lm
- Remote control (included)
- Dimmable

- Rechargeable bulb Cherry (included)
- Hanging product
- Rope: 300cm
- M Seagrass
- Packaging: 34,4 x 34,4 x 38,1 cm
- Gross Weight (with packaging): 1,35kg

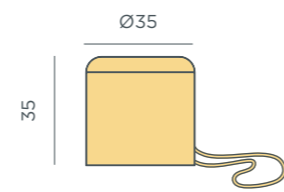

Dimensions (cm)

# Saona.



WITHOUT  
CABLES

## SAONA HANG | NATURE COLLECTION

### RECHARGEABLE BATTERY

REF: LUMSAO050XXHXNW

- IP54 Outdoor & Indoor use
- Rechargeable Battery Electric Charge (driver not included)
- Warm Light (included)
- lm 900 lm
- Remote control (included)
- Dimmable

- Rechargeable bulb Cherry (included)
- Hanging product
- Rope: 300cm
- M Rattan
- Packaging: 32,8 X 32,8 X 51,5 cm
- Gross Weight (with packaging): 1,95kg

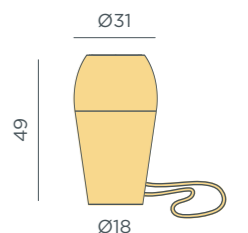

Dimensions (cm)



# Pianeta 25 | 35 | 45.

## PIANETA 25

### RECHARGEABLE BATTERY

REF: LUMPIA025XXHWNW

- IP65 Outdoor & Indoor use
- Rechargeable Battery Electric Charge (driver not included)
- Warm Light (included)
- White Light (included)
- Im 700 lm
- Remote control (included)

- Dimmable
- Hanging product
- Cable: 200 cm
- M Polyethylene | Steel cable
- Packaging: 25,5 x 25,5 x 32 cm
- Gross Weight (with packaging): 1,3kg

### HANGING CABLE

REF: LUMPIA025XXHBNW

- IP44 Outdoor & Indoor use
- Warm Light (included)
- White Light (included)
- Im 460 lm
- Remote control (included)
- Dimmable

- Hanging product
- Cable: 200 cm
- M Polyethylene | Steel cable
- Packaging: 25,5 x 25,5 x 35 cm
- Gross Weight (with packaging): 1,38kg

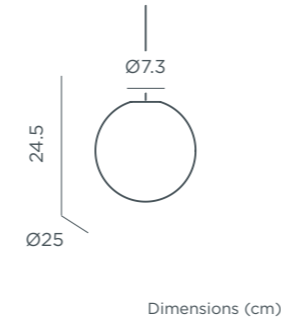

## PIANETA 35

### RECHARGEABLE BATTERY

REF: LUMPIA035XXHWNW

- IP65 Outdoor & Indoor use
- Rechargeable Battery Electric Charge (driver not included)
- Warm Light (included)
- White Light (included)
- Im 700 lm
- Remote control (included)

- Dimmable
- Hanging product
- Cable: 200 cm
- M Polyethylene | Steel cable
- Packaging: 35,5 x 35,5 x 44 cm
- Gross Weight (with packaging): 1,96kg

### HANGING CABLE

REF: LUMPIA035XXHBNW

- IP44 Outdoor & Indoor use
- Warm Light (included)
- White Light (included)
- Im 460 lm
- Remote control (included)
- Dimmable

- Hanging product
- Cable: 200 cm
- M Polyethylene | Steel cable
- Packaging: 35,5 x 35,5 x 44 cm
- Gross Weight (with packaging): 1,73kg

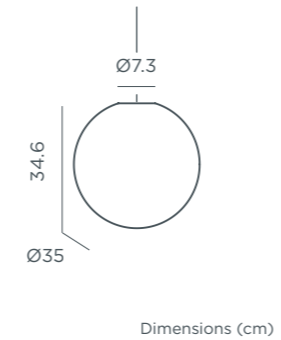

## PIANETA 45

### RECHARGEABLE BATTERY

REF: LUMPIA045XXHWNW

- IP65 Outdoor & Indoor use
- Rechargeable Battery Electric Charge (driver not included)
- Warm Light (included)
- White Light (included)
- Im 700 lm
- Remote control (included)

- Dimmable
- Hanging product
- Cable: 200 cm
- M Polyethylene | Steel cable
- Packaging: 45,5 x 45,5 x 45,5 cm
- Gross Weight (with packaging): 3,3kg

### HANGING CABLE

REF: LUMPIA045XXHBNW

- IP44 Outdoor & Indoor use
- Warm Light (included)
- White Light (included)
- Im 460 lm
- Remote control (included)
- Dimmable

- Hanging product
- Cable: 200 cm
- M Polyethylene | Steel cable
- Packaging: 46 x 46 x 46 cm
- Gross Weight (with packaging): 3,4kg

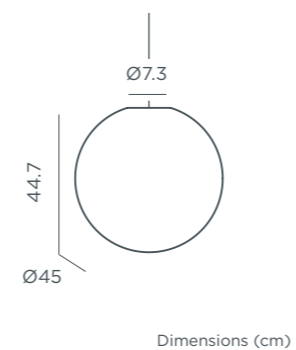



## BITA

### RECHARGEABLE BATTERY

- IP65 Outdoor & Indoor use
- Rechargeable Battery Electric Charge (driver not included)
- White Light (included)
- RGB Light (included)
- Im 300 lm
- Remote control (included)
- Dimmable
- Hanging product
- Rope: 300 cm
- M ABS
- Packaging: 18,5 x 18,5 x 29,5 cm
- Gross Weight (with packaging): 0,9kg

- Grey rope | ● REF: LUMBITAWLNLW
- Beige rope | ● REF: LUMBITAB03OWLNLW

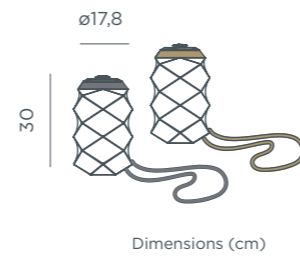

# Bita.



## SORA

### RECHARGEABLE BATTERY

- IP65 Outdoor & Indoor use
- Rechargeable Battery Electric Charge (driver not included)
- White Light (included)
- RGB Light (included)
- Im 300 lm
- Remote control (included)
- Dimmable
- Hanging product
- Rope: 300 cm
- M ABS
- Packaging: 24,6 x 24,6 x 24,6 cm
- Gross Weight (with packaging): 1kg

- Antracite rope | ● REF: LUMSORAWLNLW
- Beige rope | ● REF: LUMSORABWLNW

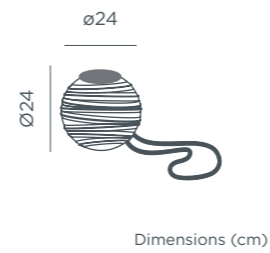

# Sora.



## NORAI

### RECHARGEABLE BATTERY

- IP65 Outdoor & Indoor use
- Rechargeable Battery Electric Charge (driver not included)
- White Light (included)
- RGB Light (included)
- Im 300 lm
- Remote control (included)
- Dimmable
- Hanging product
- Rope: 300 cm
- M ABS
- Packaging: 24,6 x 24,6 x 24,6 cm
- Gross Weight (with packaging): 1kg

- Grey rope | ● REF: LUMNR025WLNW
- Beige rope | ● REF: LUMNRB025WLNW

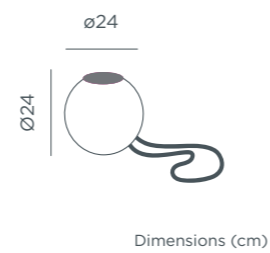

# Norai.





# Kurby.



## KURBY 38

**SOLAR & RECHARGEABLE BATTERY**

**REF: LUMKRO38SSNW**

- Outdoor & Indoor use
- Solar + Rechargeable Battery (driver not included)
- Warm Light (included)
- White Light (included)
- RGB Light (included)
- 45 lm

- Remote Control (included)
- Dimmable
- Twilight sensor
- Polyethylene | Vegan leather handle
- Packaging: 28 x 28 x 38,5 cm
- Gross Weight (with packaging): 2kg

## KURBY 38 PLAY

**RECHARGEABLE BATTERY**

**REF: LUMKRO38PLNW**

- Outdoor & Indoor use
- Rechargeable Battery Electric Charge (driver not included)
- White Light (included)
- RGB Light (included)
- 45 lm
- Remote control (included)

- Dimmable
- Play Music
- x1 Speaker
- Polyurethane | Vegan leather handle
- Packaging: 28 x 28 x 38,5 cm
- Gross Weight (with packaging): 2kg







### NÓMADA 30

**SOLAR & RECHARGEABLE BATTERY**

**REF: LUMNM032SSNW**

- Outdoor & Indoor use
- Solar + Rechargeable Battery (driver not included)
- Warm Light (included)
- White Light (included)
- RGB Light (included)
- 45 lm

- Remote control (included)
- Dimmable
- Twilight sensor
- Polyamide | Metal Handle
- Packaging: 20 x 20 x 31 cm
- Gross Weight (with packaging): 1,28kg

### NÓMADA 30 PLAY

**RECHARGEABLE BATTERY**

**REF: LUMNM032PLNW**

- Outdoor & Indoor use
- Rechargeable Battery Electric Charge (driver not included)
- White Light (included)
- RGB Light (included)
- 45 lm
- Remote control (included)

- Dimmable
- Play Music
- x1 Speaker
- Polyamide | Metal Handle
- Packaging: 20 x 20 x 31 cm
- Gross Weight (with packaging): 1,3kg

# Nómada.

# Cuby 45 Play.



### CUBY 45 PLAY

**RECHARGEABLE BATTERY**

**REF: LUMCBP45WLNW**

- Outdoor & Indoor use
- Rechargeable Battery Electric Charge (driver not included)
- White Light (included)
- RGB Light (included)
- 45 lm
- Remote control (included)

- Dimmable
- Play music
- x2 Speakers
- Polyethylene
- Packaging: 43,5 x 43,5 x 45 cm
- Gross Weight (with packaging): 5,4kg

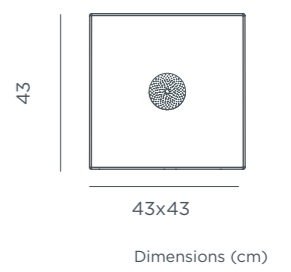
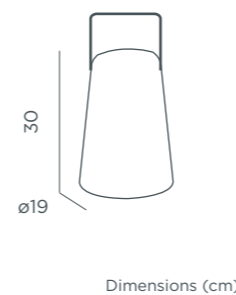



# Cherry.



## CHERRY

### RECHARGEABLE BATTERY

- IP54 Outdoor & Indoor use
- Rechargeable Battery Electric Charge (driver not included)
- Warm Light (included)
- 900 lm
- Remote Control (included)
- Dimmable
- Hanging product
- Magnetic surface
- Recycled Plastic
- Packaging: 11,5 x 11 x 9 cm
- Gross Weight (with packaging): 0,3kg

- White | ○ REF: LUMCHE011BXWLNW
- Beige | ● REF: LUMCHE011BEWLNW

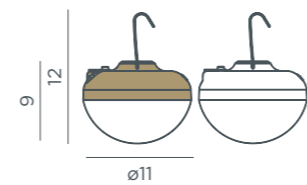

Dimensions (cm)

# Solar Cherry.

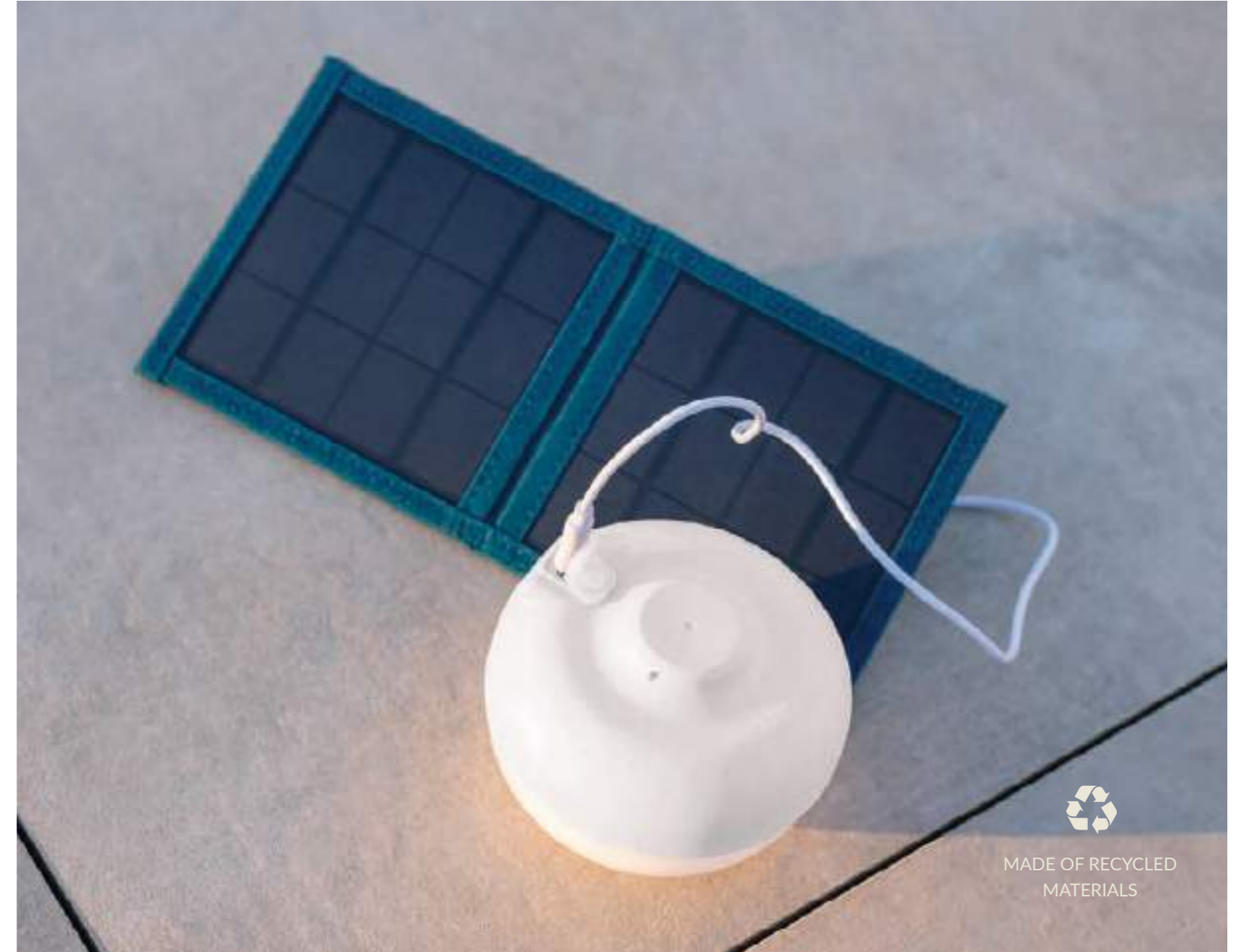

## SOLAR CHERRY

### SOLAR & RECHARGEABLE BATTERY

- IP54 Outdoor & Indoor use
- Rechargeable Battery Electric Charge (driver not included)
- Warm Light (included)
- 900 lm
- Remote control (included)
- Dimmable
- Hanging product
- Magnetic surface
- Solar panel included
- Recycled Plastic
- Packaging: 13,4 x 13,4 x 10 cm
- Gross Weight (with packaging): 0,46kg

- White | ○ REF: LUMCHS011BXWLNW
- Beige | ● REF: LUMCHS011BEWLNW

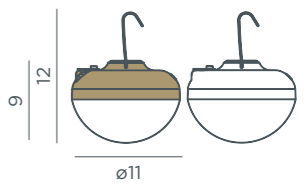

Dimensions (cm)



# Cherry Mini.





3 BULBS IN 1







 MAGNETISED

## CHERRY MINI

### RECHARGEABLE BATTERY

- IP54 Outdoor & Indoor use
-  Rechargeable Battery Electric Charge (driver not included)
-  Warm Light (included)
- Im 350 lm
-  Remote control (included)
-  Dimmable

White |  REF: LUMCHE060BXWLNW

-  Hanging product
-  Magnetic surface
-  Recycled Plastic
-  Packaging: 23 x 9 x 6,3 cm
-  Gross Weight (with packaging): 0,4kg

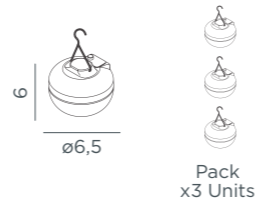

Dimensions (cm)



MADE OF RECYCLED MATERIALS



# Coco.



## COCO

### MAGNETIC PLUG

- IP68 Outdoor & Indoor use
- Magnetic Plug
- Warm Light (included)
- RGB Light (included)
- 900 lm
- Remote control (included)

White | REF: LUMCCO011BXFTNW

- Dimmable
- Hanging product
- Floating and submersible
- PP
- Packaging: 11,5 x 9 x 11,5 cm
- Gross Weight (with packaging): 0,5kg

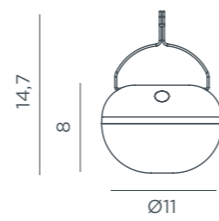

Dimensions (cm)







# Banana.



# Lima.



## BANANA

### 🔋 RECHARGEABLE BATTERY

- IP54 Outdoor & Indoor use
- 🔋 Rechargeable Battery Electric Charge (driver not included)
- 💡 Warm Light (included)
- 🌈 RGB Light (included)
- lm 900 lm
- 📶 Remote control (included)

White | ○ REF: LUMBNN035BXWLNW

- 📶 Dimmable
- 🧲 Magnetic surface
- ♻️ Recycled Plastic
- 📦 Packaging: 36 x 5 x 5 cm
- 📦 Gross Weight (with packaging): 0,4kg



Dimensions (cm)

## LIMA

### 🔋 RECHARGEABLE BATTERY

- IP54 Outdoor & Indoor use
- 🔋 Rechargeable Battery Electric Charge (driver not included)
- 💡 Warm Light (included)
- 🌈 RGB Light (included)
- lm 900 lm
- 🧲 Magnetic surface

White | ○ REF: LUMLMA020BXWLNW

- 📶 Remote control (included)
- 📶 Dimmable
- ♻️ Recycled Plastic
- 📦 Packaging: 21 x 21 x 9 cm
- 📦 Gross Weight (with packaging): 0,85kg

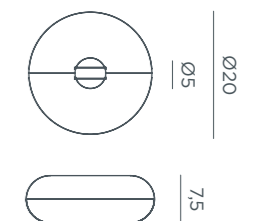

Dimensions (cm)



# Roll 8.



WITHOUT  
CABLES



MOVABLE



## ROLL 8

### RECHARGEABLE BATTERY

- IP20 Outdoor & Indoor use
- Rechargeable Battery Electric Charge (driver not included)
- Warm Light (included)
- 300 lm
- Dimmable
- Hanging product
- Magnetic Anchor
- Without electrical installation
- Easy Installation (Adhesive Pads or Screws)
- ABS
- Packaging: 8,3 x 8,2 x 8 cm
- Gross Weight (with packaging): 0,25kg

Black | ● REF: LUMROLO80NXWLNW  
White | ○ REF: LUMROLO80BXWLNW

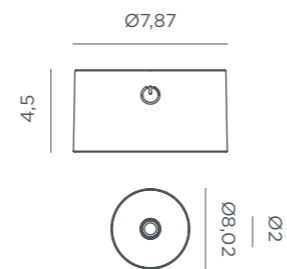

Dimensions (cm)

Compatible with Magnetic Hanging Roll Accessory (sold separately) | pag 142

# Roll 4.



WITHOUT  
CABLES



MOVABLE



## ROLL 4

### RECHARGEABLE BATTERY

- IP20 Outdoor & Indoor use
- Rechargeable Battery Electric Charge (driver not included)
- Warm Light (included)
- 300 lm
- Dimmable
- Hanging product
- Magnetic Anchor
- Without electrical installation
- Easy Installation (Adhesive Pads or Screws)
- ABS
- Packaging: 7,7 x 5,4 x 13 cm
- Gross Weight (with packaging): 0,25kg

Black | ● REF: LUMROLO40NXWLNW  
White | ○ REF: LUMROLO40BXWLNW

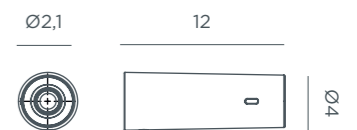

Dimensions (cm)

Compatible with Magnetic Hanging Roll Accessory (sold separately) | pag 142



# Roll Accessory.

# Box 8.



## MAGNETIC HANGING ROLL ACCESSORY

- 🔗 Hanging product
- 🧲 Magnetic Anchor
- 200 cm
- ✂ Without electrical installation
- 🔗 Easy Installation (Adhesive Pads or Screws)
- M** ABS | Metal
- 📦 Packaging: 6 x 6 x 3,5 cm
- 📦 Gross Weight: 0,04kg

- Black | ● REF: ACCRLL200NXNLNW
- White | ○ REF: ACCRLL200BXNLNW

Only for Roll 4 and Roll 8

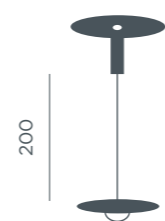

Dimensions (cm)



## BOX 8

### 🔋 RECHARGEABLE BATTERY

- IP20 Outdoor & Indoor use
- 🔋 Rechargeable Battery Electric Charge (driver not included)
- 💡 Warm Light (included)
- lm 300 lm
- 📶 Dimmable
- 🔗 Hanging product
- 🧲 Magnetic Anchor
- ✂ Without electrical installation
- 🔗 Easy Installation (Adhesive Pads or Screws)
- M** ABS
- 📦 Packaging: 8,5 x 8,2 x 10,8 cm
- 📦 Gross Weight (with packaging): 0,325kg

- Black | ● REF: LUMBOX080NXWLNW
- White | ○ REF: LUMBOX080BXWLNW

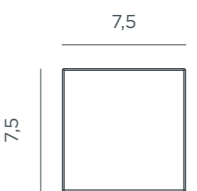

Dimensions (cm)



# Pepita.

## PEPITA 45

**SOLAR & CABLE (HYBRID)**

- IP65 Outdoor use
- Solar + Cable
- Warm Light (included)
- lm 850 lm
- Remote control (included)
- Twilight sensor

Anthracite | ● REF: LUMPEP045ANSHNW

- Motion sensor
- Solar panel included
- M** Steel
- Packaging: 16,8 x 46 x 34,3 cm
- Gross Weight (with packaging): 2,5kg

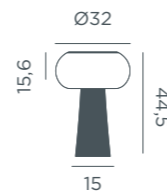

Dimensions (cm)

## PEPITA WALL

**SOLAR & CABLE (HYBRID)**

- IP65 Outdoor use
- Solar + Cable
- Warm Light (included)
- lm 850 lm
- Remote control (included)
- Twilight sensor

Anthracite | ● REF: LUMPEP036ANOPNW

- Motion sensor
- Solar panel included
- M** Steel
- Packaging: 16,8 x 46,1 x 34,3 cm
- Gross Weight (with packaging): 2,36kg

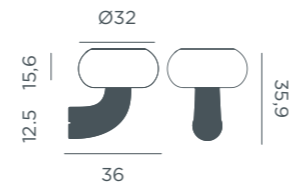

Dimensions (cm)

## PEPITA 215 | POST LAMP

**SOLAR & CABLE (HYBRID)**

- IP65 Outdoor use
- Solar + Cable
- Warm Light (included)
- lm 1550 lm
- Remote control (included)
- Twilight sensor

Anthracite | ● REF: LUMPEP215ANSHNW

- Motion sensor
- Solar panel included
- M** Steel
- Packaging: 59,5 x 54,3 x 103 cm
- Gross Weight (with packaging): 18,5kg

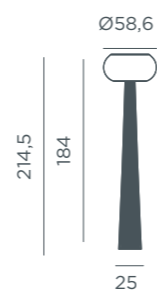

Dimensions (cm)



PEPITA WALL



PEPITA 215



PEPITA 45



# Paquita.

## PAQUITA 40

**SOLAR**

- IP65 Outdoor use
- Solar Charge
- Warm Light (included)
- 600 lm
- Remote control (included)
- Twilight sensor

Anthracite | ● REF: LUMPQTSMSLNW

- Motion sensor
- Integrated solar panel
- Steel | Anthracite Colour
- Packaging: 15,2 x 40,3 x 32,5 cm
- Gross Weight (with packaging): 3kg

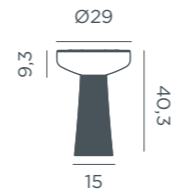

Dimensions (cm)



PAQUITA 40

## PAQUITA WALL

**SOLAR**

- IP65 Outdoor use
- Solar Charge
- Warm Light (included)
- 600 lm
- Remote control (included)
- Twilight sensor

Anthracite | ● REF: LUMPQTAPLSLNW

- Motion sensor
- Integrated solar panel
- Steel | Anthracite Colour
- Packaging: 22,3 x 29,7 x 29,8 cm
- Gross Weight (with packaging): 1,8kg



Dimensions (cm)



PAQUITA WALL

## PAQUITA 215 | POST LAMP

**SOLAR**

- IP65 Outdoor use
- Solar Charge
- Warm Light (included)
- 1200 lm
- Remote control (included)
- Twilight sensor

Anthracite | ● REF: LUMPQTFARSLNW

- Motion sensor
- Integrated solar panel
- Steel | Anthracite Colour
- Packaging: 42,5 x 59,3 x 105 cm
- Gross Weight (with packaging): 12,8kg

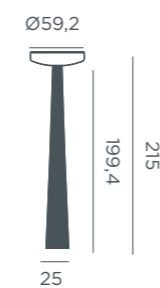

Dimensions (cm)

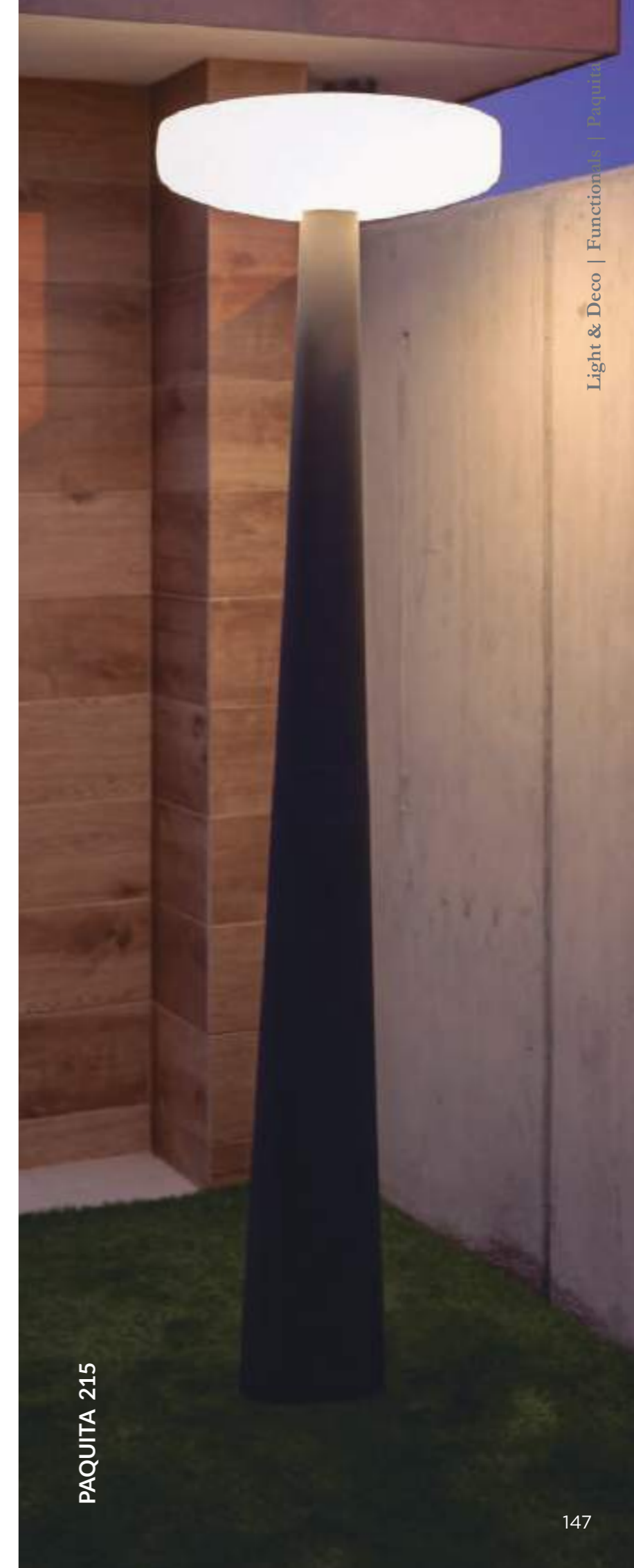

PAQUITA 215



# Sunset.



**SUNSET | POST LAMP**

- ☀️ **SOLAR**
- IP65 Outdoor use
- ⚡ Solar charging
- 💡 Neutral Light 4000k (included)
- lm 2000 lm
- 🌙 Twilight sensor

- Anthracite | ● REF: LUMSNS200SXSLNW
- 👤 Motion sensor
- ☀️ Integrated solar panel
- M** Aluminium
- 📦 Packaging: 58 x 35 x 28 cm
- 📦 Gross Weight (with packaging): 6,18kg

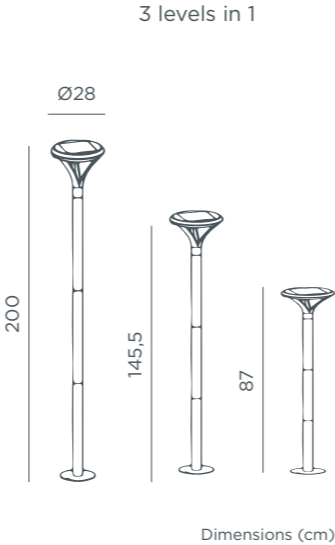



### WALLY SQUARE 12X12X12

#### SOLAR

- IP65 Outdoor use
- Solar Charge
- Warm Light (included)
- 500 lm
- Remote control (included)
- Twilight sensor

REF: LUMWLC012XXSPNW

- Motion sensor
- Solar panel included
- Recycled Plastic
- Packaging: 13,3 x 13,3 x 13,7 cm
- Gross Weight (with packaging): 0,335kg

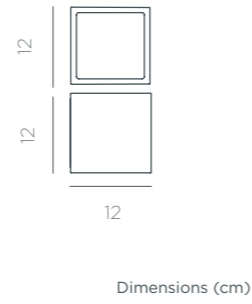

### WALLY SQUARE POT 12X12X12

- IP65 Outdoor use
- Artificial plants included
- 1,33 L

REF: JDNWAP012BXNLNW

- Recycled Plastic
- Packaging: 13,5 x 12,8 x 12,8 cm
- Gross Weight (with packaging): 0,4kg

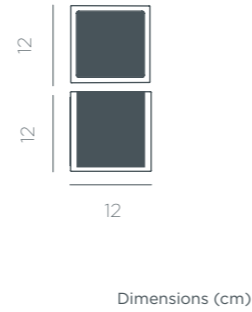

### WALLY RECTANGULAR 12X12X18

#### SOLAR

- IP65 Outdoor use
- Solar Charge
- Warm Light (included)
- 500 lm
- Remote control (included)
- Twilight sensor

REF: LUMWLP012XXSPNW

- Motion sensor
- Solar panel included
- Recycled Plastic
- Packaging: 13,3 x 13,3 x 19,7 cm
- Gross Weight (with packaging): 0,45kg

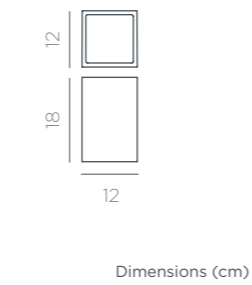

### WALLY SQUARE 18X18X18

#### SOLAR

- IP65 Outdoor use
- Solar Charge
- Warm Light (included)
- 1000 lm
- Remote control (included)
- Twilight sensor

REF: LUMWLC018XXSPNW

- Motion sensor
- Solar panel included
- Recycled Plastic
- Packaging: 19,3 x 19,3 x 19,7 cm
- Gross Weight (with packaging): 0,72kg

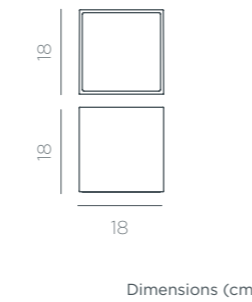

### WALLY SQUARE POT 18X18X18

- IP65 Outdoor use
- Artificial plants included
- 1,8 L

REF: JDNWAP018BXNLNW

- Recycled Plastic
- Packaging: 19,5 x 19 x 19,5 cm
- Gross Weight (with packaging): 0,72kg

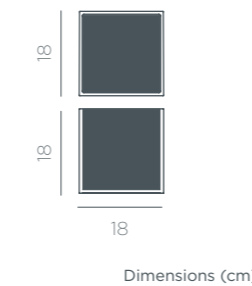

# Wally Square.



MADE OF RECYCLED MATERIALS



# Wally Disk.

## WALLY 27 DISK

### SOLAR

- IP65 Outdoor use
- Solar Charge
- Warm Light (included)
- lm 200 lm
- Remote control (included)

REF: LUMWLD027XXSPNW

- Twilight sensor
- Integrated solar panel
- Recycled Plastic
- Packaging: 28 x 6,5 x 28 cm
- Gross Weight (with packaging): 0,65kg

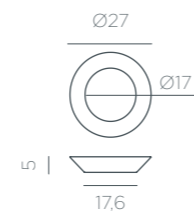

Dimensions (cm)

## WALLY 39 DISK

### SOLAR

- IP65 Outdoor use
- Solar Charge
- Warm Light (included)
- lm 200 lm
- Remote control (included)

REF: LUMWLD039XXSPNW

- Twilight sensor
- Integrated solar panel
- Recycled Plastic
- Packaging: 40 x 9,5 x 40 cm
- Gross Weight (with packaging): 1,15kg



Dimensions (cm)

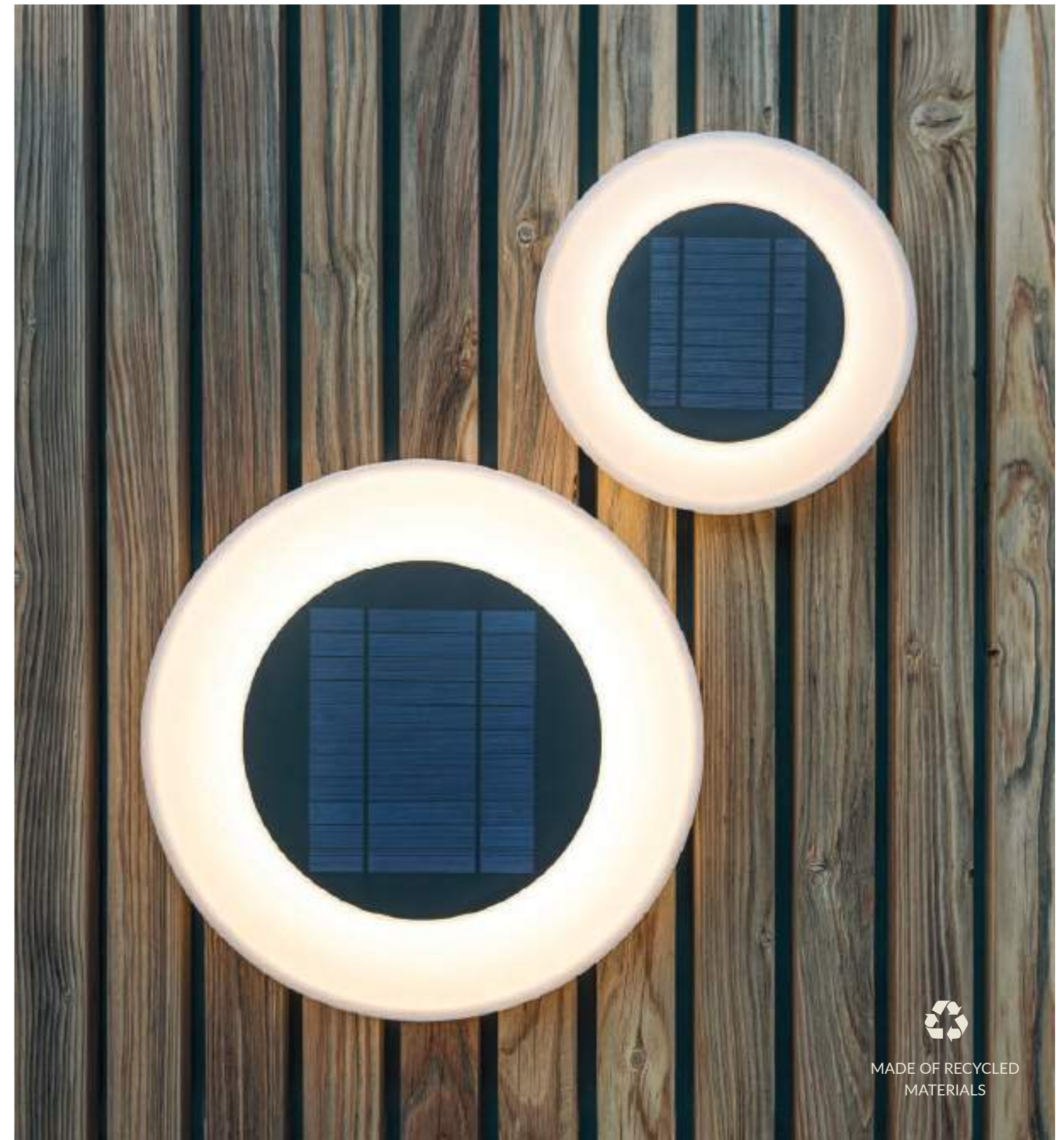

MADE OF RECYCLED MATERIALS



# Bossa.



## BOSSA WALL LAMP | NATURE COLLECTION

### RECHARGEABLE BATTERY

- IP54 Outdoor & Indoor use
- Rechargeable Battery Electric Charge (driver not included)
- Warm Light (included)
- 900 lm
- Remote control (included)

REF: LUMBOS025XXWLNW

- Dimmable
- Rechargeable bulb Cherry (included)
- Rattan
- Packaging: 27,5 X 21,2 X 16,3 cm
- Gross Weight (with packaging): 0,93kg

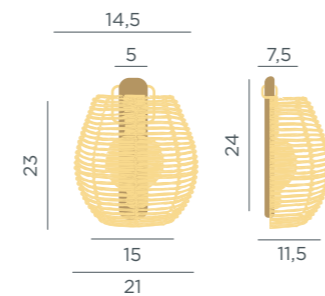

Dimensions (cm)

# Sisine.



## SISINE 25 WALL LAMP | NATURE COLLECTION

### RECHARGEABLE BATTERY

- IP54 Outdoor & Indoor use
- Rechargeable Battery Electric Charge (driver not included)
- Warm Light (included)
- 900 lm
- Remote control (included)

REF: LUMSIS025XXWLNW

- Dimmable
- Rechargeable bulb Cherry (included)
- Seagrass
- Packaging: 21,2 x 27,2 x 16,3 cm
- Gross Weight (with packaging): 1,37kg

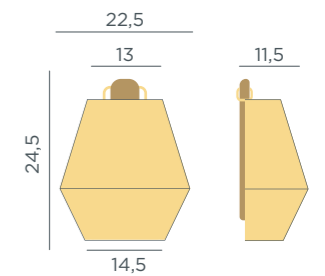

Dimensions (cm)



# Saona.



# Conta.



MADE OF RECYCLED MATERIALS

## SAONA WALL LAMP | NATURE COLLECTION

### RECHARGEABLE BATTERY

- IP54 Outdoor & Indoor use
- Rechargeable Battery Electric Charge (driver not included)
- Warm Light (included)
- 900 lm
- Remote control (included)

REF: LUMSAO025XXWLNW

- Dimmable
- Rechargeable bulb Cherry (included)
- Rattan
- Packaging: 27,5 x 21,2 x 16,3 cm
- Gross Weight (with packaging): 0,96kg

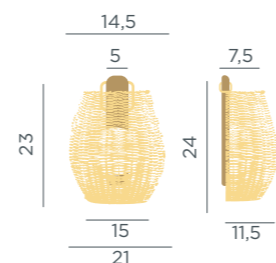

## CONTA WALL LAMP

### RECHARGEABLE BATTERY

- IP54 Outdoor & Indoor use
- Rechargeable Battery Electric Charge (driver not included)
- Warm Light (included)
- 900 lm
- Remote control (included)

Taupe grey | REF: LUMCNT025SXWLNW

- Dimmable
- Rechargeable bulb Cherry (included)
- Recycled PVC
- Packaging: 27,5 x 21,2 x 16,3 cm
- Gross Weight (with packaging): 1,03kg

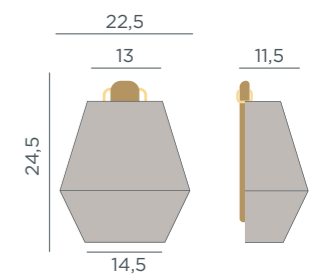



# Buly Collection.



















# Petra.

## PETRA 40

### SOLAR & RECHARGEABLE BATTERY

REF: LUMPT040SSNW



-  Outdoor & Indoor use
-  Solar + Rechargeable Battery (driver not included)
-  Warm Light (included)
-  White Light (included)
-  RGB Light (included)
-  45 lm
-  Remote control (included)

-  Dimmable
-  Twilight sensor
-  Solar panel included
-  Polyethylene
-  Packaging: 29,5 x 40,3 x 20,5 cm
-  Gross Weight (with packaging): 1,3kg

### SOLAR AUTOMATIC



REF: LUMPT040SANW



-  Outdoor use
-  Solar Charge
-  White light (included)
-  16 lm
-  Twilight sensor

-  Solar panel included
-  Polyethylene
-  Packaging: 29,5 x 40,3 x 20,5 cm
-  Gross Weight (with packaging): 1,3kg

### CABLE

REF: LUMPT040OFNW







-  Outdoor & Indoor use
-  White light (included)
-  250 lm

-  Polyethylene
-  Packaging: 29,5 x 40,3 x 20,5 cm
-  Gross Weight (with packaging): 1,3kg

## PETRA 60

### SOLAR & RECHARGEABLE BATTERY

REF: LUMPT060SSNW



-  Outdoor & Indoor use
-  Solar + Rechargeable Battery (driver not included)
-  Warm Light (included)
-  White Light (included)
-  RGB Light (included)
-  45 lm
-  Remote control (included)

-  Dimmable
-  Twilight sensor
-  Solar panel included
-  Polyethylene
-  Packaging: 44,3 x 60,2 x 30,8 cm
-  Gross Weight (with packaging): 2,5kg

### CABLE

REF: LUMPT060OFNW

-  Outdoor & Indoor use
-  White light (included)
-  600 lm

-  Polyethylene
-  Packaging: 44,3 x 60,2 x 30,8 cm
-  Gross Weight (with packaging): 3kg

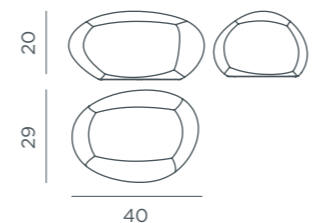

Dimensions (cm)

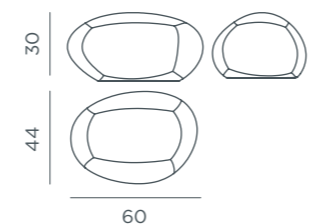

Dimensions (cm)





# Cuby Collection.

## CUBY

### SOLAR & RECHARGEABLE BATTERY

- IP65 Outdoor & Indoor use
- Solar + Rechargeable battery
- Warm Light (included)
- White Light (included)
- RGB Light (included)
- Im 45 lm
- Remote control (included)
- Dimmable
- Twilight sensor
- M Polyethylene

Cuby 20

#### REF: LUMCB020SSNW

- Packaging: 26,5 x 30,3 x 30,3 cm
- Gross Weight (with packaging): 1,1kg

Cuby 32

#### REF: LUMCB032SSNW

- Packaging: 34,8 x 32,5 x 32,5 cm
- Gross Weight (with packaging): 2,7kg

Cuby 40

#### REF: LUMCB040SSNW

- Packaging: 42 x 40,6 x 40,6 cm
- Gross Weight (with packaging): 4kg

Cuby 45

#### REF: LUMCB045SSNW

- Packaging: 45 x 43,5 x 43,5 cm
- Gross Weight (with packaging): 5kg

Cuby 53

#### REF: LUMCB053SSNW

- Packaging: 43,6 x 43,6 x 55 cm
- Gross Weight (with packaging): 5,5kg

### CABLE (WARM LIGHT)

- IP65 Outdoor & Indoor use
- Warm Light (included)
- Im 600 lm
- M Polyethylene

Cuby 32

#### REF: LUMCB032OCNW

- Packaging: 34,8 x 32,5 x 32,5 cm
- Gross Weight (with packaging): 2,7kg

Cuby 40

#### REF: LUMCB040CFNW

- Packaging: 42 x 40,6 x 40,6 cm
- Gross Weight (with packaging): 4kg

Cuby 45

#### REF: LUMCB045OCNW

- Packaging: 45 x 43,5 x 43,5 cm
- Gross Weight (with packaging): 5kg

### CABLE (WHITE LIGHT)

- IP65 Outdoor & Indoor use
- White Light (included)
- Im 600 lm | Cuby 20: 250 lm
- M Polyethylene

Cuby 20

#### REF: LUMCB0200FNW

- Packaging: 26,5 x 30,3 x 30,3 cm
- Gross Weight (with packaging): 1,1kg

Cuby 32

#### REF: LUMCB0320FNW

- Packaging: 34,8 x 32,5 x 32,5 cm
- Gross Weight (with packaging): 2,7kg

Cuby 40

#### REF: LUMCB0400FNW

- Packaging: 42 x 40,6 x 40,6 cm
- Gross Weight (with packaging): 4,5kg

Cuby 45

#### REF: LUMCB0450FNW

- Packaging: 45 x 43,5 x 43,5 cm
- Gross Weight (with packaging): 5kg

Cuby 53

#### REF: LUMCB0530FNW

- Packaging: 43,6 x 43,6 x 55 cm
- Gross Weight (with packaging): 5,5kg

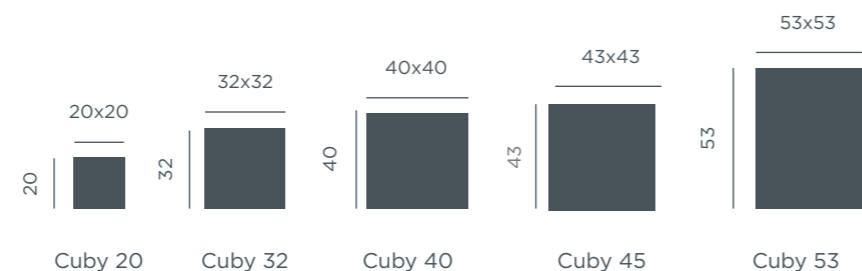

Dimensions (cm)





*special for*  
**Swimming-pool**





# Papaya 12.

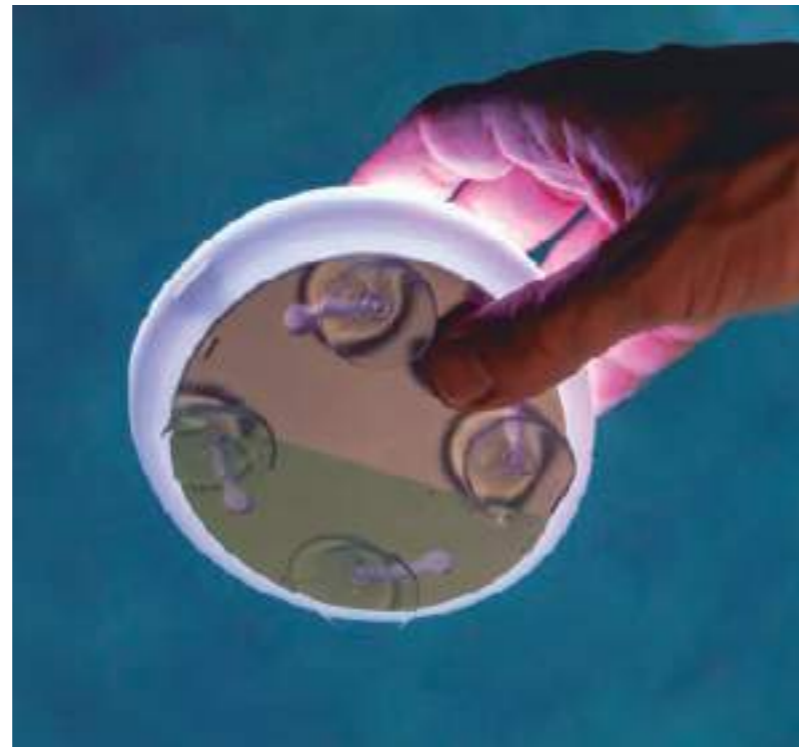

# Papaya 30.

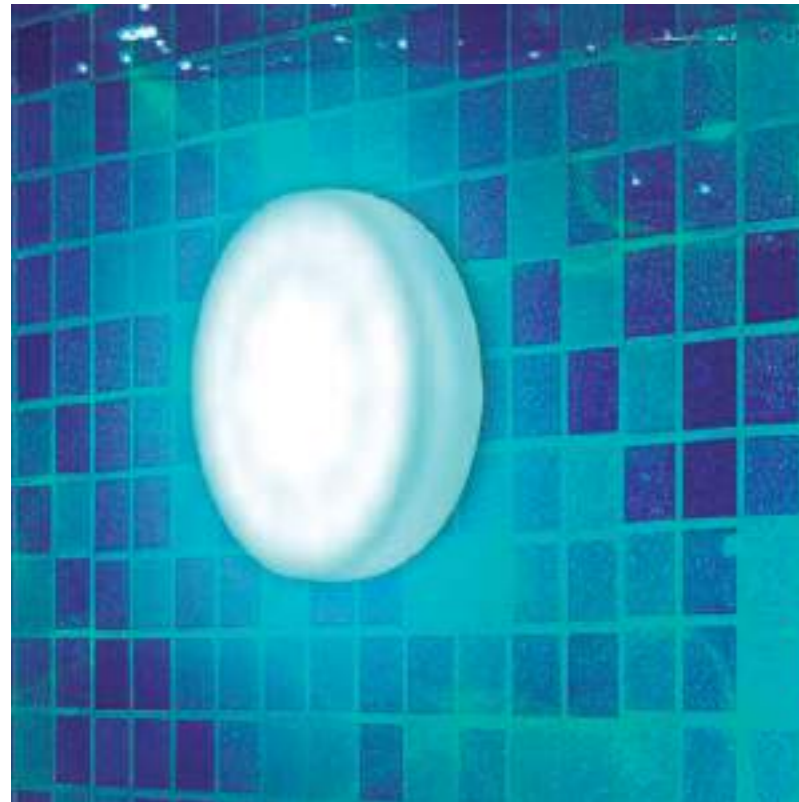

## PAPAYA 12

**MAGNETIC RECHARGEABLE BATTERY**

**REF: LUMPPY012XXWLNW**

- Outdoor use
- Magnetic rechargeable battery
- Warm Light (included)
- White Light (included)
- RGB Light (included)
- 800 lm

- Remote control (included)
- Dimmable
- Floating & submersible
- Polycarbonate
- Packaging: 12,5 x 12,5 x 5,3 cm
- Gross Weight (with packaging): 0,6kg

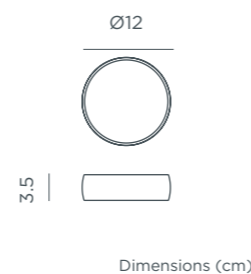

## PAPAYA 30

**SOLAR & MAGNETIC RECHARGEABLE BATTERY**

**REF: LUMPPY030XXSLNW**

- Outdoor use
- Solar + Magnetic rechargeable battery
- Warm Light (included)
- White Light (included)
- RGB Light (included)
- 800 lm
- Remote control (included)

- Dimmable
- Floating & submersible
- Solar panel included
- Polycarbonate
- Packaging: 29,5 x 4,3 x 29,5 cm
- Gross Weight (with packaging): 1,16kg

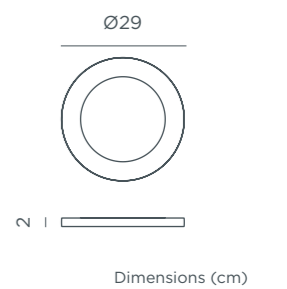



# Buly Floating.



# Play Disk 40.



## BULY 20/30/40 | FLOATING

### SOLAR

- IP68 Outdoor use
- Solar Charge
- Warm Light (included)
- White Light (included)
- RGB Light (included)
- 45 lm
- Remote control (included)
- Dimmable
- Twilight sensor
- Floating, not submersible
- M Polyethylene

Buly 20

#### REF: LUMBLO20FTNW

- Packaging: 20,3 x 20,3 x 19,5 cm
- Gross Weight (with packaging): 0,8kg

Buly 30

#### REF: LUMBLO30FTNW

- Packaging: 31,5 x 31,5 x 29 cm
- Gross Weight (with packaging): 1,2kg

Buly 40

#### REF: LUMBLO40FTNW

- Packaging: 36,6 x 40,3 x 40,3 cm
- Gross Weight (with packaging): 1,9kg

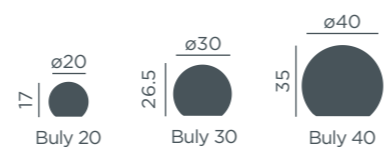

Dimensions (cm)

## BULY 20

### SOLAR

- IP68 Outdoor use
- Solar Charge
- White Light (included)
- 16 lm
- Twilight sensor

#### REF: LUMBLO20SANW

- Floating, not submersible
- M Polyethylene
- Packaging: 20,3 x 20,3 x 19,5 cm
- Gross Weight (with packaging): 0,8kg

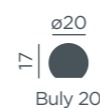

Dimensions (cm)

## PLAY DISK 40

### RECHARGEABLE BATTERY

#### REF: LUMPKO40XXPLNW

- IP67 Outdoor & Indoor use
- Rechargeable Battery Electric Charge (driver not included)
- RGB Light (included)
- 900 lm
- Remote control (included)
- Dimmable

- Play Music
- Floating, not submersible
- M Polyethylene
- Packaging: 39,5 x 6,5 x 39,5 cm
- Gross Weight (with packaging): 2,65kg
- Up to two Play Disk can be connected

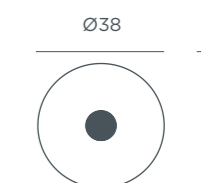

Dimensions (cm)



COCO | FLOATING PORTABLE LIGHT BULB | + INFO PAG 136.



*Indoor &  
Christmas*





# INDOOR COLLECTION

+ Ask us and discover our complete Indoor Collection.

PRODUCTS

(1) ROLL & BOX COLLECTION | INFO PAG 140  
(5) LOLA SLIM 30

(2) AMALFI 80 HANG INDOOR  
(6) SAONA HANG INDOOR

(3) SAONA INDOOR  
(7) LOLA SLIM 180

(4) BULY 30 INDOOR  
(8) SISINE 70 INDOOR

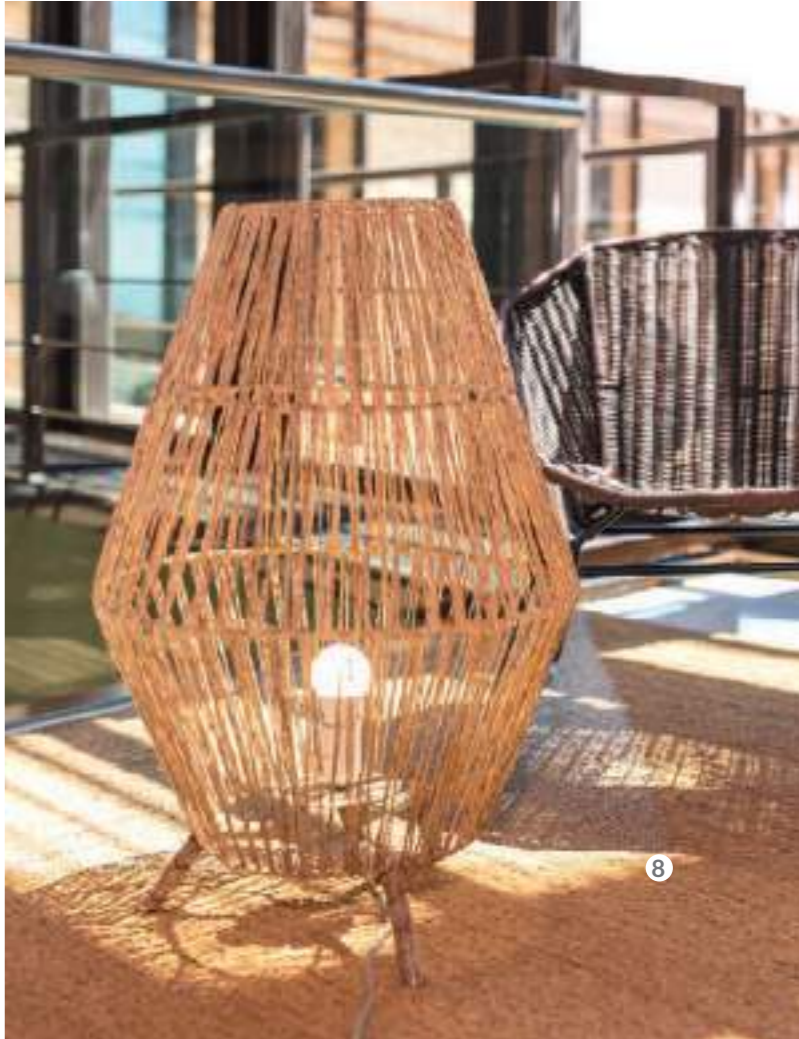



# CHRISTMAS COLLECTION

+ Ask us and discover our complete Christmas Collection.

PRODUCTS  
(1) PALLINA GARLAND (2) BIANCA GARLAND (3) LUA (4) GIFTY COLLECTION (5) SISINE STAR 60 (6) PINUS COLLECTION







*furniture*



# Paradise MODE ON

## PRODUCTS

(1) HIAMA  
(5) HORTENSIA 30

(2) AURORA GARLAND  
(6) CHLOE 140

(3) NIZA 165  
(7) RASA

(4) TARIDA TAB  
(8) SIROCO





# Rasa.



## RASA | WHITE OPAQUE COLOUR

White |  REF: MOBRASABXNW

- M** Polyethylene
-  Packaging: 81,5 x 205 x 36 cm
-  Gross Weight (with packaging): 22kg

## RASA | CIRCOOLAR

Recycled Multicolour |  REF: MOBRAS200BXNLCR

- M** Recycled detergent bottles
-  Packaging: 81,5 x 205 x 36 cm
-  Gross Weight (with packaging): 22kg

  Made of recycled detergent bottles

## RASA | CIRCOOLAR

Recycled Blue |  REF: MOBRAS200AZNLCR

- M** Recycled fishing nets
-  Packaging: 81,5 x 205 x 36 cm
-  Gross Weight (with packaging): 22kg

  Made of recycled fishing nets

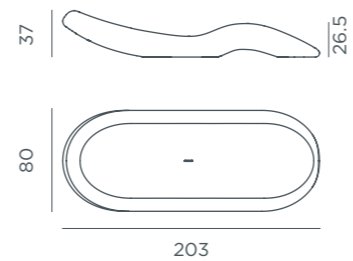

203

Dimensions (cm)





# Formentera.





# Formentera.

## FORMENTERA

### SOLAR & RECHARGEABLE BATTERY

REF: MOBFR160SSNW

- IP65 Outdoor & Indoor use
- Solar + Rechargeable Battery (driver not included)
- Warm Light (included)
- White Light (included)
- RGB Light (included)
- 45X4 lm (Lumens per bulb)
- Remote control (included)

- Dimmable
- Twilight sensor
- Integrated solar panel
- Polyethylene
- Packaging: Plastic bag
- Gross Weight (with packaging): 41kg

### CABLE

REF: MOBFR160OFNW

- IP65 Outdoor & Indoor use
- White Light (included)
- 600 lm

- Polyethylene
- Packaging: Plastic bag
- Gross Weight (with packaging): 41kg

### WHITE OPAQUE COLOUR

REF: MOBFR160BXNW

- Polyethylene

- Packaging: Plastic bag
- Gross Weight (with packaging): 41kg

White Formentera mattress | 140 x 112 x 8 cm

REF: MOBCNF140BXNLNW

White Formentera pillow | 50 x 50 cm

REF: MOBCNC050BXNLNW

White Formentera pillow | 60 x 60 cm

REF: MOBCNR060BXNLNW

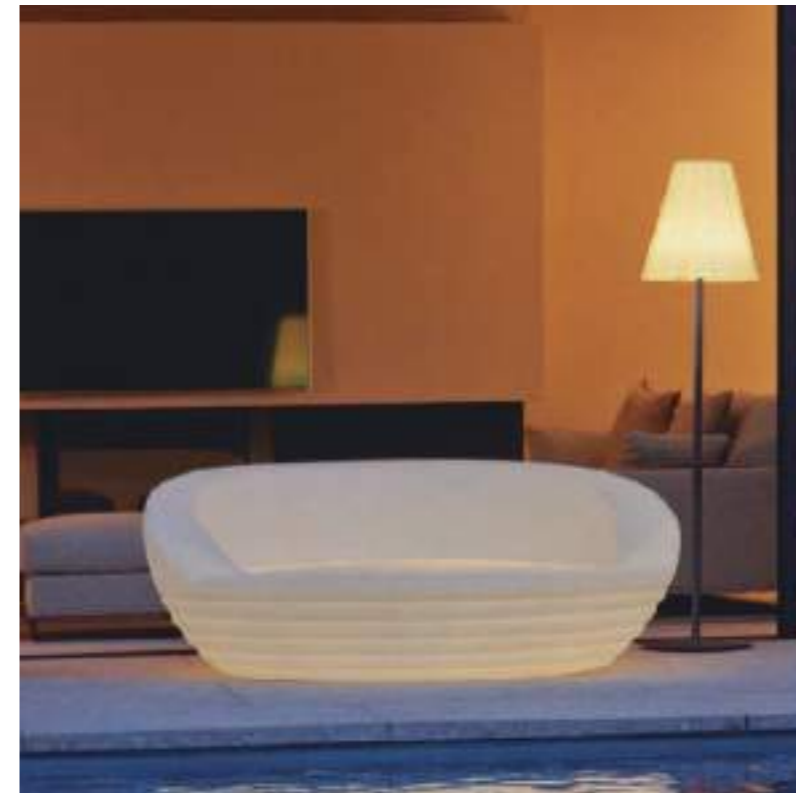
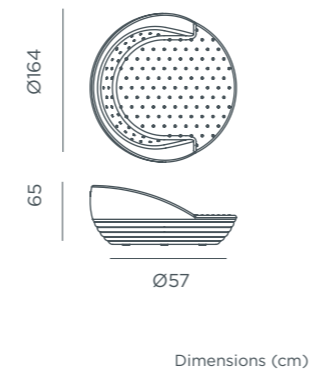



# New Island.

## MARTINICA TAB

SOLAR & RECHARGEABLE BATTERY

REF: MOBMESSASSNW

- IP65 Outdoor & Indoor use
- Solar + Rechargeable Battery (driver not included)
- Warm Light (included)
- White Light (included)
- RGB Light (included)
- lm 45 lm
- Remote control (included)

- Dimmable
- Twilight sensor
- Integrated solar panel
- M** Polyethylene
- Packaging: 101 x 101 x 36 cm
- Gross Weight (with packaging): 10kg

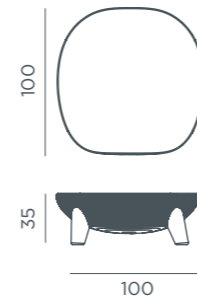

Dimensions (cm)



## ARUBA SIT

SOLAR & RECHARGEABLE BATTERY

REF: MOBSILARSSNW

- IP65 Outdoor & Indoor use
- Solar + Rechargeable Battery (driver not included)
- Warm Light (included)
- White Light (included)
- RGB Light (included)
- lm 45 lm
- Remote control (included)

- Dimmable
- Twilight sensor
- Integrated solar panel
- M** Polyethylene
- Packaging: 81,5 x 81 x 82,5 cm
- Gross Weight (with packaging): 15,5kg

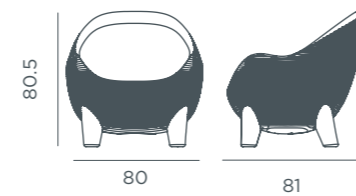

Dimensions (cm)

WHITE OPAQUE COLOUR

REF: MOBSILARBXNW

**M** Polyethylene

- Packaging: 81,5 x 81 x 82,5 cm
- Gross Weight (with packaging): 11,5kg

## JAMAICA SOFA

SOLAR & RECHARGEABLE BATTERY

REF: MOBSC1200FNW

- IP65 Outdoor & Indoor use
- Solar + Rechargeable Battery (driver not included)
- Warm Light (included)
- White Light (included)
- RGB Light (included)
- lm 45x2 lm (lumens per bulb)
- Remote control (included)

- Dimmable
- Twilight sensor
- Integrated solar panel
- M** Polyethylene
- Packaging: 210 x 81,5 x 80,5 cm
- Gross Weight (with packaging): 30,5kg

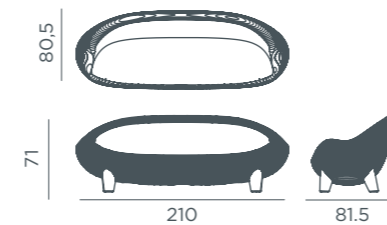

Dimensions (cm)

CABLE

REF: MOBSC1200FNW

- IP65 Outdoor & Indoor use
- White Light (included)
- lm 600 lm

- M** Polyethylene
- Packaging: Plastic bag
- Gross Weight (with packaging): 30,5kg

WHITE OPAQUE COLOUR

REF: MOBSC120BXNW

**M** Polyethylene

- Packaging: Plastic bag
- Gross Weight (with packaging): 30,5kg







MADE OF RECYCLED MATERIALS

Furniture | Sets | Tarida

# Tarida Set.

CIRCOLAR





# Tarida Set.

## TARIDA TAB

### SOLAR & RECHARGEABLE BATTERY

REF: MOBTDT30SSNW

- IP65 Outdoor & Indoor use
- Solar + Rechargeable Battery (driver not included)
- Warm Light (included)
- White Light (included)
- RGB Light (included)
- 45 lm
- Remote control (included)

- Dimmable
- Twilight sensor
- Integrated solar panel
- Polyethylene | Methacrylate cover
- Packaging: 45,6 x 59,6 x 31,5 cm
- Gross Weight (with packaging): 6kg

### RECHARGEABLE BATTERY

REF: MOBTDT30PLNW

- IP43 Outdoor & Indoor use
- Rechargeable Battery Electric Charge (driver not included)
- White Light (included)
- RGB Light (included)
- 45 lm
- Remote control (included)

- Dimmable
- Play music
- x2 Speakers
- Polyethylene | Methacrylate cover
- Packaging: 45,6 x 59,6 x 31,5 cm
- Gross Weight (with packaging): 6,8kg

## WHITE OPAQUE COLOUR

White | REF: MOBTDT30BXNW

- Polyethylene | Methacrylate cover
- Packaging: 45,6 x 59,6 x 31,5 cm
- Gross Weight (with packaging): 4,5kg

## TARIDA TAB | CIRCOOLAR

Recycled Multicolour | REF: MOBTDT030BXNLCR

- Recycled detergent bottles
- Packaging: 45,6 x 59,6 x 31,5 cm
- Gross Weight (with packaging): 4,5kg

Made of recycled detergent bottles

## TARIDA TAB | CIRCOOLAR

Recycled Blue | REF: MOBTDT030AZNLCR

- Recycled fishing nets
- Packaging: 45,6 x 59,6 x 31,5 cm
- Gross Weight (with packaging): 4,5kg

Made of recycled fishing nets

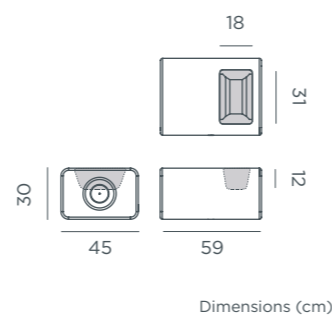

Dimensions (cm)

## TARIDA SIT

### SOLAR & RECHARGEABLE BATTERY

White | REF: MOBTDS66SSNW

- IP65 Outdoor & Indoor use
- Solar + Rechargeable Battery (driver not included)
- Warm Light (included)
- White Light (included)
- RGB Light (included)
- 600 lm
- Remote control (included)

- Dimmable
- Twilight sensor
- Integrated solar panel
- Polyethylene
- Packaging: 69 x 77 x 66,5 cm
- Gross Weight (with packaging): 8,5kg

## TARIDA SIT | CIRCOOLAR

Recycled Multicolour | REF: MOBTDS066BXNLCR

- Recycled detergent bottles
- Packaging: 69 x 77 x 66,5 cm
- Gross Weight (with packaging): 8,5kg

Made of recycled detergent bottles

## TARIDA SIT | CIRCOOLAR

Recycled Blue | REF: MOBTDS066AZNLCR

- Recycled fishing nets
- Packaging: 69 x 77 x 66,5 cm
- Gross Weight (with packaging): 8,5kg

Made of recycled fishing nets

Pillow included

## TARIDA SIT ARMS

### SOLAR & RECHARGEABLE BATTERY

REF: MOBTDS66ARMSSNW

- IP65 Outdoor & Indoor use
- Solar + Rechargeable Battery (driver not included)
- Warm Light (included)
- White Light (included)
- RGB Light (included)
- 600 lm
- Remote control (included)

- Dimmable
- Twilight sensor
- Integrated solar panel
- Polyethylene | Steel arms (wood effect)
- Packaging: 69 x 77 x 66,5 cm
- Gross Weight (with packaging): 12kg

## WHITE OPAQUE COLOUR

REF: MOBTDS66ARMBXNW

- 80% PVC, 18% PES, 2% PU | Steel arms

- Packaging: 69 x 77 x 66,5 cm
- Gross Weight (with packaging): 12kg

Pillow included

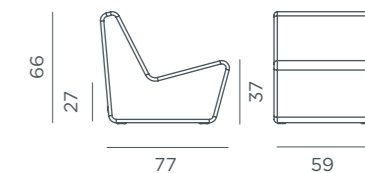

Dimensions (cm)

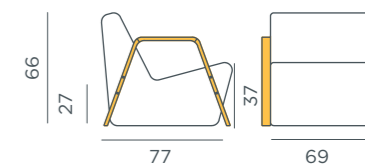

Dimensions (cm)



# Tafy & Cuby.



## CUBY 53 | CIRCOOLAR

Recycled Multicolour | ● REF: MOBCBY053BXNLCR

- M Recycled detergent bottles
- 📦 Packaging: 40,5 x 40,5 x 40 cm
- 📦 Gross Weight (with packaging): 2,9kg

♻️ Made of recycled detergent bottles

## CUBY 53 | CIRCOOLAR

Recycled Blue | ● REF: MOBCBY053AZNLCR

- M Recycled fishing nets
- 📦 Packaging: 40,5 x 40,5 x 40 cm
- 📦 Gross Weight (with packaging): 2,9kg

♻️ Made of recycled fishing nets

## CUBY 53

See other versions on pag. 164

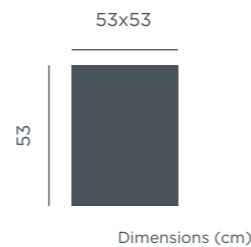

# Tafy & Pufy.



## TAFY 38

- M Polyethylene
- 📦 Packaging: 40,5 x 40,5 x 40 cm
- 📦 Gross Weight (with packaging): 2,9kg

White | ○ REF: MOBTF038BXNW  
Black | ● REF: MOBTF038NXNW

## TAFY | CIRCOOLAR

Recycled Multicolour | ● REF: MOBTFY038BXNLCR

- M Recycled detergent bottles
- 📦 Packaging: 40,5 x 40,5 x 40 cm
- 📦 Gross Weight (with packaging): 2,9kg

♻️ Made of recycled detergent bottles

## TAFY | CIRCOOLAR

Recycled Blue | ● REF: MOBTFY038AZNLCR

- M Recycled fishing nets
- 📦 Packaging: 40,5 x 40,5 x 40 cm
- 📦 Gross Weight (with packaging): 2,9kg

♻️ Made of recycled fishing nets

## PUFY 45

- M Polyethylene

White | ○ REF: MOBPF045BXNW

- 📦 Packaging: 45 x 43,5 x 43,5 cm
- 📦 Gross Weight (with packaging): 4kg

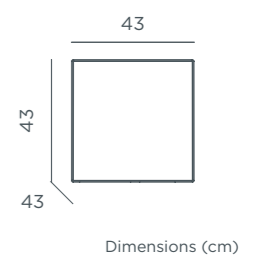
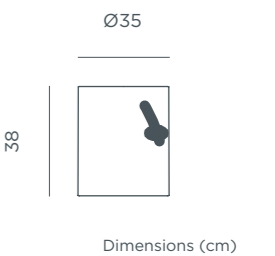



# Capri 40 & Corfu 40.

## CAPRI 40 TAB

SOLAR & RECHARGEABLE BATTERY

REF: MOBCP040SSNW

- IP65 Outdoor & Indoor use
- Solar + Rechargeable Battery (driver not included)
- Warm Light (included)
- White Light (included)
- RGB Light (included)
- 45 lm
- Remote control (included)

- Dimmable
- Twilight sensor
- Integrated solar panel
- Polyethylene | Methacrylate cover
- Packaging: 60 x 60 x 42 cm
- Gross Weight (with packaging): 4,5kg

WHITE OPAQUE COLOUR

REF: MOBCP040BXNW

Polyethylene & Methacrylate cover

- Packaging: 60 x 60 x 42 cm
- Gross Weight (with packaging): 4kg

## CORFU 40 SIT

SOLAR & RECHARGEABLE BATTERY

REF: MOBCF040SSNW

- IP65 Outdoor & Indoor use
- Solar + Rechargeable Battery (driver not included)
- Warm Light (included)
- White Light (included)
- RGB Light (included)
- 45 lm
- Remote control (included)

- Dimmable
- Twilight sensor
- Integrated solar panel
- Polyethylene
- Packaging: 40,5 x 40,5 x 40 cm
- Gross Weight (with packaging): 3,5kg

WHITE OPAQUE COLOUR

REF: MOBCF040BXNW

Polyethylene  
 Packaging: 40,5 x 40,5 x 40 cm  
 Gross Weight (with packaging): 3kg



Ø58



Ø36

39

Dimensions (cm)



Ø40



Ø33

38

Dimensions (cm)





# Capri 75 & Mallorca.

## CAPRI 75 TAB

SOLAR & RECHARGEABLE BATTERY

REF: MOBPC075SSNW

- IP65 Outdoor & Indoor use
- Solar + Rechargeable Battery (driver not included)
- Warm Light (included)
- White Light (included)
- RGB Light (included)
- 45 lm
- Remote control (included)

- Dimmable
- Twilight sensor
- Integrated solar panel
- Polyethylene | Methacrylate cover
- Packaging: 102 x 100 x 74,4 cm
- Gross Weight (with packaging): 18kg

WHITE OPAQUE COLOUR

REF: MOBPC075BXNW

- Polyethylene | Methacrylate cover

- Packaging: 102 x 100 x 74,4 cm
- Gross Weight (with packaging): 18kg

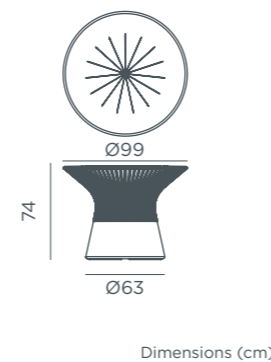

## MALLORCA SIT

SOLAR & RECHARGEABLE BATTERY

REF: MOBMA060SSNW

- IP65 Outdoor & Indoor use
- Rechargeable Battery Electric Charge (driver not included)
- Warm Light (included)
- White Light (included)
- RGB Light (included)
- 45 lm
- Remote control (included)

- Dimmable
- Twilight sensor
- Integrated solar panel
- Polyethylene
- Packaging: 60 x 60 x 73 cm
- Gross Weight (with packaging): 7,5kg

WHITE OPAQUE COLOUR

REF: MOBMA060BXNW

- Polyethylene

- Packaging: 60 x 60 x 73 cm
- Gross Weight (with packaging): 7kg

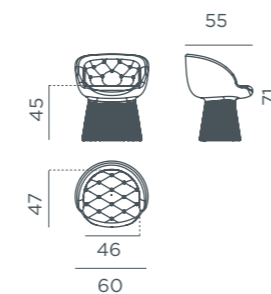



# Capri 110 & Corfu 74.

## CAPRI 110 TAB

### 🔋 RECHARGEABLE BATTERY

REF: MOBCP110TWLNW

- 🏠 IP65 Outdoor & Indoor use
- 🔋 Rechargeable Battery Electric Charge (driver not included)
- 💡 White Light (included)
- 🌈 RGB Light (included)
- 💡 110 lm
- 📱 Remote control (included)

- 📶 Dimmable
- 💡 Led tube lighting (included)
- 📦 Polyethylene | Methacrylate cover
- 📦 Packaging: 60 x 60 x 113 cm
- 📦 Gross Weight (with packaging): 10kg

### ○ WHITE OPAQUE COLOUR

REF: MOBCP110BXNW

- 📦 Polyethylene | Methacrylate cover

- 📦 Packaging: 60 x 60 x 113 cm
- 📦 Gross Weight (with packaging): 8,5kg

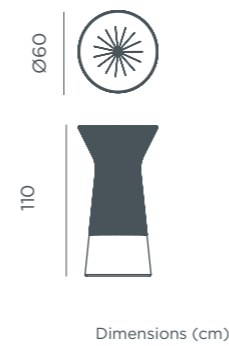

## CORFU 74 SIT

### 🔋 + ☀️ SOLAR & RECHARGEABLE BATTERY

REF: MOBCF074SSNW

- 🏠 IP65 Outdoor & Indoor use
- 🔋 Rechargeable Battery Electric Charge (driver not included)
- 💡 Warm Light (included)
- 💡 White Light (included)
- 🌈 RGB Light (included)
- 💡 45 lm
- 📱 Remote control (included)

- 📶 Dimmable
- 🌙 Twilight sensor
- ☀️ Integrated solar panel
- 📦 Polyethylene
- 📦 Packaging: 40 x 40 x 74,8 cm
- 📦 Gross Weight (with packaging): 5,5kg

### ○ WHITE OPAQUE COLOUR

REF: MOBCF074BXNW

- 📦 Polyethylene

- 📦 Packaging: 40 x 40 x 74,8cm
- 📦 Gross Weight (with packaging): 5kg

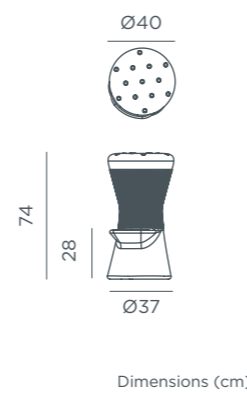



# Itaca & Mallorca.

## ITACA 60 TAB

SOLAR & RECHARGEABLE BATTERY

REF: MOBITC60SSNW

- Outdoor & Indoor use
- Rechargeable Battery Electric Charge (driver not included)
- Warm Light (included)
- White Light (included)
- RGB Light (included)
- 45 lm
- Remote control (included)

- Dimmable
- Twilight sensor
- Integrated solar panel
- Polyethylene | White phenolic cover
- Packaging: 36,5 x 36,5 x 71,5 cm
- Gross Weight (with packaging): 12,6kg

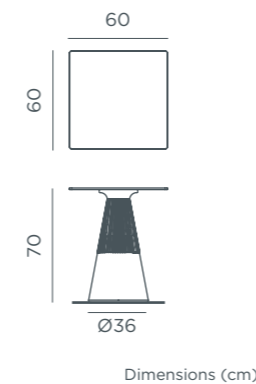

## MALLORCA SIT

SOLAR & RECHARGEABLE BATTERY

REF: MOBMA060SSNW

- Outdoor & Indoor use
- Rechargeable Battery Electric Charge (driver not included)
- Warm Light (included)
- White Light (included)
- RGB Light (included)
- 45 lm
- Remote control (included)

- Dimmable
- Twilight sensor
- Integrated solar panel
- Polyethylene
- Packaging: 60 x 60 x 73 cm
- Gross Weight (with packaging): 7,5kg

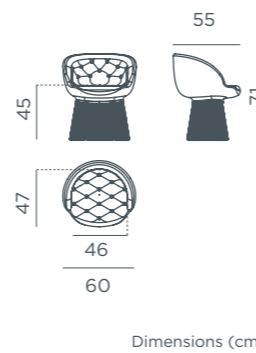

WHITE OPAQUE COLOUR

REF: MOBMA060BXNW

- Polyethylene

- Packaging: 60 x 60 x 73 cm
- Gross Weight (with packaging): 7kg







**BORA WOOD**

# Bora.

**BORA MARBLE**



## BORA

### JUTE CABLE

- IP65 Outdoor & Indoor use
- ☀️ Warm Light (included)
- 💡 White Light (included)
- lm 860 lm
- 📡 Remote control (included)
- 🔊 Dimmable

- Marble | ○ **REF: LUMBORAMBXINOUTNW**
  - M Ceramic | Polyethylene
  - 📦 Packaging: 44 x 44 x 47 cm
  - 📊 Gross Weight (with packaging): 8,2kg
- Wood | ● **REF: LUMBORAWBXINOUTNW**
  - M Bamboo | Polyethylene
  - 📦 Packaging: 44 x 44 x 45,5cm
  - 📊 Gross Weight (with packaging): 6,54kg

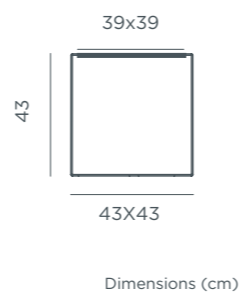



# Sicilia 75.

## SICILIA 75

### ☀️ + 🔋 SOLAR & RECHARGEABLE BATTERY

REF: MOBSC075SSNW

- IP65 Outdoor & Indoor use
- ☀️ Solar + Rechargeable Battery (driver not included)
- 💡 Warm Light (included)
- 💡 White Light (included)
- 💡 RGB Light (included)
- lm 45 lm
- 📶 Remote control (included)

- 📶 Dimmable
- 🌙 Twilight sensor
- ☀️ Integrated solar panel
- M Polyethylene | Methacrylate cover
- 📦 Packaging: 75 x 76,5 x 118,5 cm
- 📦 Gross Weight (with packaging): 33kg

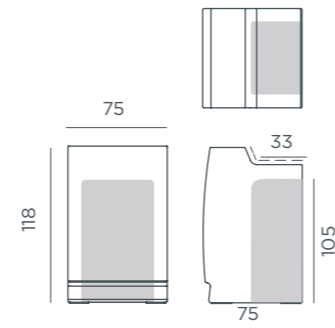

Dimensions (cm)



# Sicilia 120.

## SICILIA 120

### ☀️ + 🔋 SOLAR & RECHARGEABLE BATTERY

REF: MOBSC120SSNW

- IP65 Outdoor & Indoor use
- ☀️ Solar + Rechargeable Battery (driver not included)
- 💡 Warm Light (included)
- 💡 White Light (included)
- 💡 RGB Light (included)
- lm 45 lm
- 📶 Remote control (included)

- 📶 Dimmable
- 🌙 Twilight sensor
- ☀️ Integrated solar panel
- M Polyethylene | Methacrylate cover
- 📦 Packaging: 120 x 76,5 x 118,5 cm
- 📦 Gross Weight (with packaging): 40kg

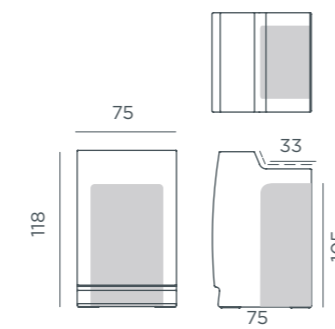

Dimensions (cm)

### 🔌 CABLE

REF: MOBSC120OFNW

- IP65 Outdoor & Indoor use
- 💡 White Light (included)
- lm 2800 lm
- LED Led tube lighting (included)

- M Polyethylene | Methacrylate cover
- 📦 Packaging: 120 x 76,5 x 118,5 cm
- 📦 Gross Weight (with packaging): 40kg

### ○ WHITE OPAQUE COLOUR

REF: MOBSC120BXNW

- M Polyethylene | Methacrylate cover

- 📦 Packaging: 120 x 76,5 x 118,5 cm
- 📦 Gross Weight (with packaging): 40kg





# Ibiza 120.



## IBIZA 120

### SOLAR & RECHARGEABLE BATTERY

REF: MOBBZ120SSNW

- IP65 Outdoor & Indoor use
- Solar + Rechargeable Battery (driver not included)
- Warm Light (included)
- White Light (included)
- RGB Light (included)
- 45 lm
- Remote control (included)

- Dimmable
- Twilight sensor
- Integrated solar panel
- Polyethylene | Methacrylate cover
- Packaging: 80 x 120 x 113 cm
- Gross Weight (with packaging): 23,8kg

### CABLE

REF: MOBBZ120OFNW

- IP65 Outdoor & Indoor use
- White Light (included)
- 600 lm

- Polyethylene | Methacrylate cover
- Packaging: 80 x 120 x 113 cm
- Gross Weight (with packaging): 23,8kg

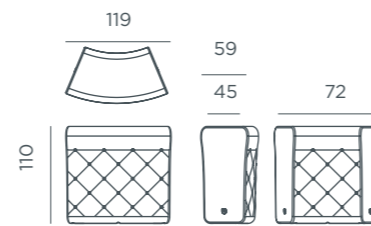

Dimensions (cm)



# Creta 120.



## CRETA 120

### ☀️ + 🔋 SOLAR & RECHARGEABLE BATTERY

REF: MOBCR120SSNW

- IP65 Outdoor & Indoor use
- 🔋 Rechargeable Battery Electric Charge (driver not included)
- 💡 Warm Light (included)
- 💡 White Light (included)
- 💡 RGB Light (included)
- 💡 45 lm
- 📡 Remote control (included)

- 📏 Dimmable
- 🌙 Twilight sensor
- ☀️ Integrated solar panel
- M Polyethylene | Methacrylate cover
- 📦 Packaging: 120 x 66 x 111,5 cm
- 📊 Gross Weight (with packaging): 27kg

### 🔌 CABLE

REF: MOBCR120OFNW

- IP65 Outdoor & Indoor use
- 💡 White Light (included)
- 💡 600 lm

- M Polyethylene | Methacrylate cover
- 📦 Packaging: 120 x 66 x 111,5 cm
- 📊 Gross Weight (with packaging): 27kg

Shelf accessory | 21 x 101 x 1 cm

REF: MOBCRE101BXNLNW

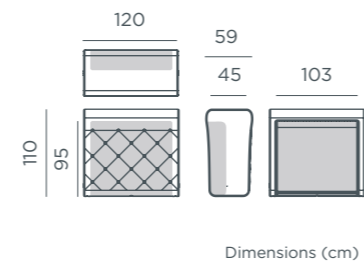



# Palma Bottle.



## PALMA BOTTLE RACK

SOLAR & RECHARGEABLE BATTERY

REF: LUMPMB70SSNW

- Outdoor & Indoor use
- Solar + Rechargeable Battery (driver not included)
- Warm Light (included)
- White Light (included)
- RGB Light (included)
- 45 lm
- Remote control (included)

- Dimmable
- Twilight sensor
- Integrated solar panel
- Polyethylene
- Packaging: 35,5 x 35,5 x 70 cm
- Gross Weight (with packaging): 2,42kg

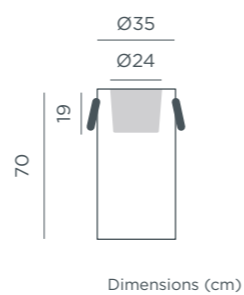

## COOLER ACESORY

### BAMBU COOLER

REF: LUMCLB035XXNLNW

Outdoor & Indoor use

- Aluminium
- Packaging: 35 x 18 x 35 cm
- Gross Weight (with packaging): 5kg

### PALMA COOLER

REF: LUMCLP035XXNLNW

Outdoor & Indoor use

- Aluminium
- Packaging: 35 x 18 x 35 cm
- Gross Weight (with packaging): 2,42kg

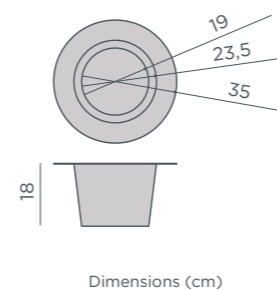

# Woody.



## WOODY

SOLAR & RECHARGEABLE BATTERY

REF: LUMWD070SSNW

- Outdoor & Indoor use
- Solar + Rechargeable Battery (driver not included)
- Warm Light (included)
- White Light (included)
- RGB Light (included)
- 45 lm
- Remote control (included)

- Dimmable
- Twilight sensor
- Integrated solar panel
- Cooler accessory included
- Polyurethane | Synthetic leather handle
- Packaging: 40,5 x 40,5 x 70 cm
- Gross Weight (with packaging): 5kg

## WOODY PLAY

RECHARGEABLE BATTERY

REF: LUMWD070PLNW

- Outdoor & Indoor use
- Rechargeable Battery Electric Charge (driver not included)
- White Light (included)
- RGB Light (included)
- 45 lm
- Remote control (included)

- Dimmable
- Play music
- x1 Speaker
- Cooler accessory included
- Polyurethane | Synthetic leather handle
- Packaging: 40,5 x 40,5 x 70 cm
- Gross Weight (with packaging): 5,2kg

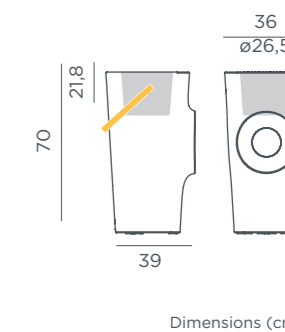





*Flowerpots*



# Azalea Collection.

## AZALEA 30

- 9,4 L
- Includes water reservoir
- M Polyethylene
- Packaging: Plastic bag
- Gross Weight (with packaging): 1kg

- White | ○ REF: JDNAZA030BXNLNW
- Black | ● REF: JDNAZA030NXNLNW
- Bronze | ● REF: JDNAZA030ZXNLNW
- Terracota | ● REF: JDNAZA030TXNLNW
- Anthracite | ● REF: JDNAZA030ANLNLNW

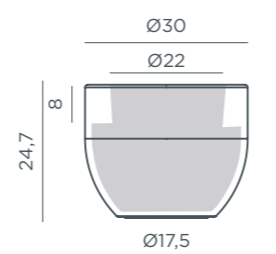

Dimensions (cm)

## AZALEA 40

- 19,7 L
- Includes water reservoir
- M Polyethylene
- Packaging: Plastic bag
- Gross Weight (with packaging): 2kg

- White | ○ REF: JDNAZA040BXNLNW
- Black | ● REF: JDNAZA040NXNLNW
- Bronze | ● REF: JDNAZA040ZXNLNW
- Terracota | ● REF: JDNAZA040TXNLNW
- Anthracite | ● REF: JDNAZA040ANLNLNW

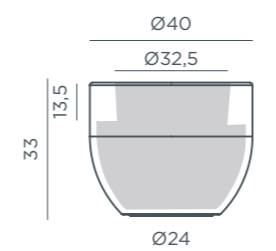

Dimensions (cm)

## AZALEA 50

- 37,8 L
- Includes water reservoir
- M Polyethylene
- Packaging: Plastic bag
- Gross Weight (with packaging): 3,5kg

- White | ○ REF: JDNAZA050BXNLNW
- Black | ● REF: JDNAZA050NXNLNW
- Bronze | ● REF: JDNAZA050ZXNLNW
- Terracota | ● REF: JDNAZA050TXNLNW
- Anthracite | ● REF: JDNAZA050ANLNLNW

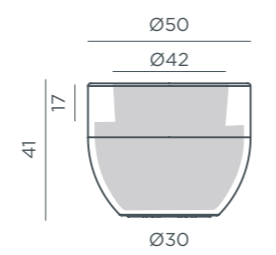

Dimensions (cm)





## HORTENSIA 30

- 17,8 L
- Includes water reservoir
- M Polyethylene
- Packaging: Plastic bag
- Gross Weight (with packaging): 1kg

- White | ○ REF: JDNHOR030BXNW
- Black | ● REF: JDNHOR030NXNW
- Bronze | ● REF: JDNHOR030ZXNW
- Taupe | ● REF: JDNHOR030KXNW
- Terracota | ● REF: JDNHOR030TXNW
- Anthracite | ● REF: JDNHOR030ANNW

### HORTENSIA 30 | CIRCOOLAR

Recycled Multicolour | ● REF: LUMHOR030BXNLCR

- 17,8 L
- M Recycled detergent cans
- Packaging: Plastic bag
- Gross Weight (with packaging): 1kg

Made of recycled detergent bottles

### HORTENSIA 30 | CIRCOOLAR

Recycled Blue | ● REF: LUMHOR030AZNLCR

- 17,8 L
- M Recycled fishing nets
- Packaging: Plastic bag
- Gross Weight (with packaging): 1kg

Made of recycled fishing nets

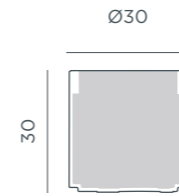

Dimensions (cm)

## LIFT SUPPORT ACCESORIES | ONLY FOR HORTENSIA 30

### SUPPORT ACCESSORY 41cm

- M Lacquered Iron
- Packaging: 29,2 x 36,9 x 2 cm
- Gross Weight (with packaging): 0,67kg

- Black | ● REF: JDNLIFT30041NXNW
- Brass | ● REF: JDNLIFT30041BRNW

### SUPPORT ACCESSORY 101cm

- M Lacquered Iron
- Packaging: 29,5 x 97 x 2,5 cm
- Gross Weight (with packaging): 1,62kg

- Black | ● REF: JDNLIFT30110NXNW
- Brass | ● REF: JDNLIFT30110BRNW

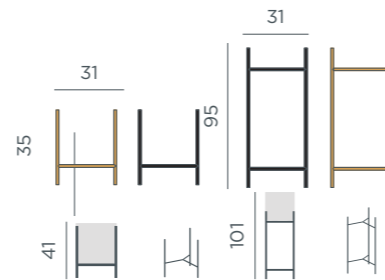

Dimensions (cm)

## HORTENSIA 40 HIGH

- 83,4 L
- Includes water reservoir
- M Polyethylene
- Packaging: Plastic bag
- Gross Weight (with packaging): 4kg

- White | ○ REF: JDNHOH040BXNLNW
- Black | ● REF: JDNHOH040NXNLNW
- Bronze | ● REF: JDNHOH040ZXNLNW
- Taupe | ● REF: JDNHOH040KXNLNW
- Terracota | ● REF: JDNHOH040TXNLNW
- Anthracite | ● REF: JDNHOH040ANNLNW

### HORTENSIA 40 HIGH | CIRCOOLAR

Recycled Multicolour | ● REF: LUMHOH040BXNLCR

- 83,4 L
- M Recycled detergent cans
- Packaging: Plastic bag
- Gross Weight (with packaging): 4kg

Made of recycled detergent bottles

### HORTENSIA 40 HIGH | CIRCOOLAR

Recycled Blue | ● REF: LUMHOH040AZNLCR

- 83,4 L
- M Recycled fishing nets
- Packaging: Plastic bag
- Gross Weight (with packaging): 4kg

Made of recycled fishing nets

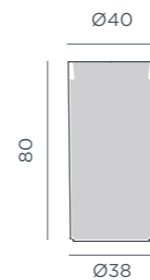

Dimensions (cm)

# Hortensia Collection.





## HORTENSIA 40

- 40 L
- Includes water reservoir
- M Polyethylene
- Packaging: Plastic bag
- Gross Weight (with packaging): 2,5kg

- White | ○ REF: JDNHOR040BXNW
- Black | ● REF: JDNHOR040NXNW
- Bronze | ● REF: JDNHOR040ZXNW
- Taupe | ● REF: JDNHOR040KXNW
- Terracota | ● REF: JDNHOR040TXNW
- Anthracite | ● REF: JDNHOR040ANNW

### HORTENSIA 40 | CIRCOOLAR

Recycled Multicolour | ● REF: LUMHOR040BXNLCR

- 40 L
- M Recycled detergent cans
- Packaging: Plastic bag
- Gross Weight (with packaging): 2,5kg

♻️ Made of recycled detergent bottles

### HORTENSIA 40 | CIRCOOLAR

Recycled Blue | ● REF: LUMHOR040AZNLCR

- 40 L
- M Recycled fishing nets
- Packaging: Plastic bag
- Gross Weight (with packaging): 2,5kg

♻️ Made of recycled fishing nets

## HORTENSIA 50

- 81 L
- Includes water reservoir
- M Polyethylene
- Packaging: Plastic bag
- Gross Weight (with packaging): 4kg

- White | ○ REF: JDNHOR050BXNW
- Black | ● REF: JDNHOR050NXNW
- Bronze | ● REF: JDNHOR050ZXNW
- Taupe | ● REF: JDNHOR050KXNW
- Terracota | ● REF: JDNHOR050TXNW
- Anthracite | ● REF: JDNHOR050ANNW

### HORTENSIA 50 | CIRCOOLAR

Recycled Multicolour | ● REF: LUMHOR050BXNLCR

- 81 L
- M Recycled detergent cans
- Packaging: Plastic bag
- Gross Weight (with packaging): 4kg

♻️ Made of recycled detergent bottles

### HORTENSIA 50 | CIRCOOLAR

Recycled Blue | ● REF: LUMHOR050AZNLCR

- 81 L
- M Recycled fishing nets
- Packaging: Plastic bag
- Gross Weight (with packaging): 4kg

♻️ Made of recycled fishing nets

## HORTENSIA 80 BIG SIZE XXL

- 343 L
- Includes water reservoir
- M Polyethylene
- Packaging: Plastic bag
- Gross Weight (with packaging): 12kg

- White | ○ REF: JDNHOR080BXNW
- Black | ● REF: JDNHOR080NXNW
- Bronze | ● REF: JDNHOR080ZXNW
- Terracota | ● REF: JDNHOR080TXNW
- Anthracite | ● REF: JDNHOR080ANNW

### HORTENSIA 80 | CIRCOOLAR

Recycled Multicolour | ● REF: LUMHOR080BXNLCR

- 343 L
- M Recycled detergent cans
- Packaging: Plastic bag
- Gross Weight (with packaging): 4kg

♻️ Made of recycled detergent bottles

### HORTENSIA 80 | CIRCOOLAR

Recycled Blue | ● REF: LUMHOR080AZNLCR

- 343 L
- M Recycled fishing nets
- Packaging: Plastic bag
- Gross Weight (with packaging): 4kg

♻️ Made of recycled fishing nets

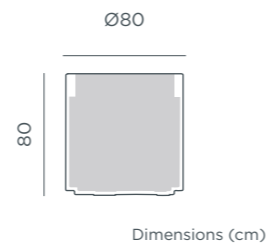
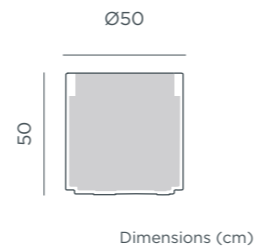
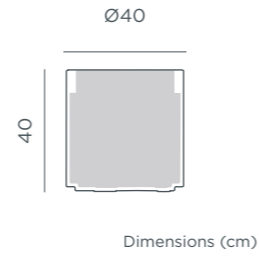

HORTENSIA HIGH





# Magnolia 30.

## MAGNOLIA 30 | WITH LIGHT

**SOLAR & RECHARGEABLE BATTERY**

REF: LUMMG030SSNW

- IP65 Outdoor & Indoor use
- Solar + Rechargeable Battery (driver not included)
- Warm Light (included)
- White Light (included)
- RGB Light (included)
- Im 45 lm
- Remote control (included)

- Dimmable
- Twilight sensor
- 3,7 L
- Integrated solar panel
- M** Polyethylene
- Packaging: 32,5 x 32,5 x 33 cm
- Gross Weight (with packaging): 1,7kg

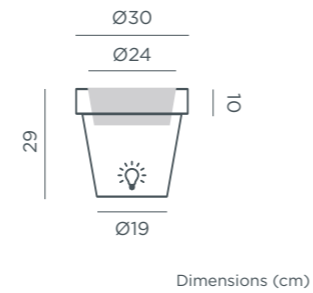

## MAGNOLIA 30 | WITHOUT LIGHT

**OPAQUE COLOUR**

- 7,9 L
- M** Polyethylene
- Packaging: Plastic bag
- Gross Weight (with packaging): 0,9kg

- White | ○ REF: JDNMG030BXNW
- Black | ● REF: JDNMG030NXNW
- Bronze | ● REF: JDNMG030ZXNW
- Anthracite | ● REF: JDNMG030ANNW

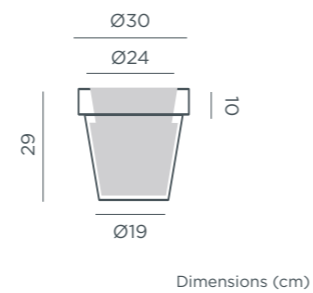

# Magnolia 45.

## MAGNOLIA 45 | WITH LIGHT

**SOLAR & RECHARGEABLE BATTERY**

REF: LUMMG045SSNW

- IP65 Outdoor & Indoor use
- Solar + Rechargeable Battery (driver not included)
- Warm Light (included)
- White Light (included)
- RGB Light (included)
- Im 45 lm
- Remote control (included)

- Dimmable
- Twilight sensor
- 19,4 L
- Integrated solar panel
- M** Polyethylene
- Packaging: 46 x 46 x 46,5 cm
- Gross Weight (with packaging): 4,75kg

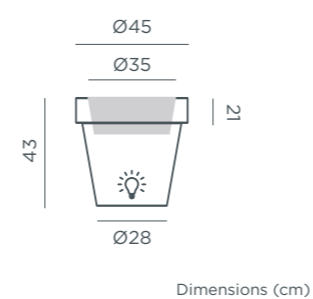

**CABLE**

REF: LUMMG045OFNW

- IP65 Outdoor & Indoor use
- White Light (included)
- Im 600 lm
- 19,4 L

- M** Polyethylene
- Packaging: 46 x 46 x 46,5 cm
- Gross Weight (with packaging): 4kg

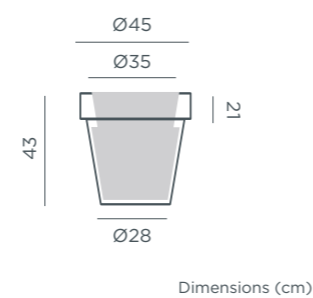

## MAGNOLIA 45 | WITHOUT LIGHT

**OPAQUE COLOUR**

- 33,4 L
- M** Polyethylene
- Packaging: Plastic bag
- Gross Weight (with packaging): 2kg

- White | ○ REF: JDNMG045BXNW
- Black | ● REF: JDNMG045NXNW
- Bronze | ● REF: JDNMG045ZXNW
- Anthracite | ● REF: JDNMG045ANNW

# Magnolia Collection.





# Magnolia 60.



# Magnolia 80.



## MAGNOLIA 60 | WITH LIGHT

SOLAR & RECHARGEABLE BATTERY

REF: LUMMG060SSNW

- IP65 Outdoor & Indoor use
- Solar + Rechargeable Battery (driver not included)
- Warm Light (included)
- White Light (included)
- RGB Light (included)
- lm 45 lm
- Remote control (included)

- Dimmable
- Twilight sensor
- 36,7 L
- Integrated solar panel
- M** Polyethylene
- Packaging: 59 x 59 x 59 cm
- Gross Weight (with packaging): 7kg

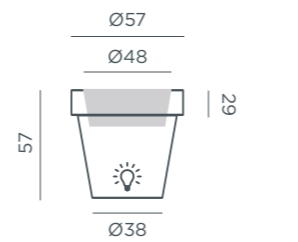

Dimensions (cm)

CABLE

REF: LUMMG060OFNW

- IP65 Outdoor & Indoor use
- White Light (included)
- lm 600 lm
- 36,7 L

- M** Polyethylene
- Packaging: 59 x 59 x 59 cm
- Gross Weight (with packaging): 7kg

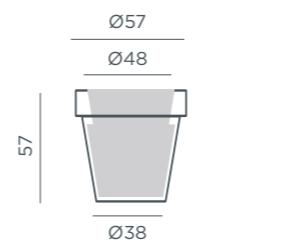

Dimensions (cm)

## MAGNOLIA 60 | WITHOUT LIGHT

OPAQUE COLOUR

- 82,3 L
- M** Polyethylene
- Packaging: Plastic bag
- Gross Weight (with packaging): 5kg

- White | REF: JDNMG060BXNW
- Black | REF: JDNMG060NXNW
- Bronze | REF: JDNMG060ZXNW
- Anthracite | REF: JDNMG060ANNW

## MAGNOLIA 80 | WITH LIGHT BIG SIZE

SOLAR & RECHARGEABLE BATTERY

REF: JDNMGN080XXSSNW

- IP65 Outdoor & Indoor use
- Solar + Rechargeable Battery (driver not included)
- Warm Light (included)
- White Light (included)
- RGB Light (included)
- lm 600 lm
- Remote control (included)

- Dimmable
- Twilight sensor
- 82,5 L
- Integrated solar panel
- M** Polyethylene
- Packaging: Plastic bag
- Gross Weight (with packaging): 16kg

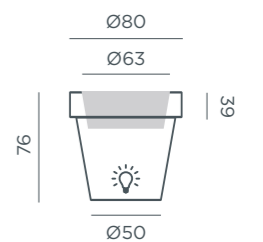

Dimensions (cm)

CABLE

REF: JDNMGN080XXOFNW

- IP65 Outdoor & Indoor use
- White Light (included)
- lm 600 lm
- 82,5 L

- M** Polyethylene
- Packaging: Plastic bag
- Gross Weight (with packaging): 16kg

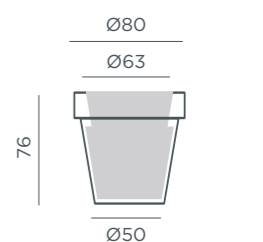

Dimensions (cm)

## MAGNOLIA 80 | WITHOUT LIGHT

OPAQUE COLOUR

- 207 L
- Includes water reservoir
- M** Polyethylene
- Packaging: Plastic bag
- Gross Weight (with packaging): 15kg

- White | REF: JDNMGN080BXNLNW
- Black | REF: JDNMGN080NXNLNW
- Bronze | REF: JDNMGN080ZXNLNW
- Anthracite | REF: JDNMGN080ANNLNW





# Magnolia 120.

# Magnolia 160.



## MAGNOLIA 120 | WITH LIGHT BIG SIZE XXL

**SOLAR & RECHARGEABLE BATTERY**

**REF: JDNMGN120XXSSNW**

- Outdoor & Indoor use
- Solar + Rechargeable Battery (driver not included)
- Warm Light (included)
- White Light (included)
- RGB Light (included)
- 600 lm
- Remote control (included)

- Dimmable
- Twilight sensor
- 282.2 L
- Integrated solar panel
- Polyethylene
- Packaging: Plastic bag
- Gross Weight (with packaging): 36kg

**CABLE**

**REF: JDNMGN120XXOFNW**

- Outdoor & Indoor use
- White Light (included)
- 600 lm
- 282.2 L

- Polyethylene
- Packaging: Plastic bag
- Gross Weight (with packaging): 36kg

## MAGNOLIA 120 | WITHOUT LIGHT BIG SIZE XXL

**OPAQUE COLOUR**

- 752.6 L
- Polyethylene
- Packaging: Plastic bag
- Gross Weight (with packaging): 35kg

- White | **REF: JDNMGN120BXNLNW**
- Black | **REF: JDNMGN120NXNLNW**
- Bronze | **REF: JDNMGN120ZXNLNW**
- Anthracite | **REF: JDNMGN120ANNLNW**

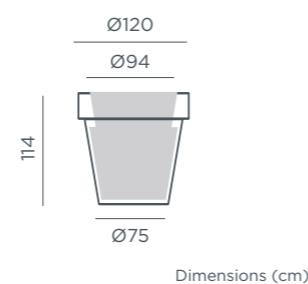
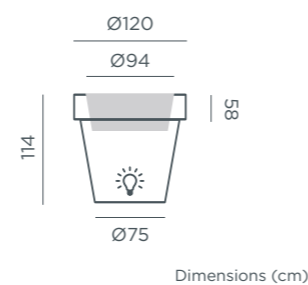

## MAGNOLIA 160 | WITH LIGHT

**SOLAR & RECHARGEABLE BATTERY** BIG SIZE XXL

**REF: JDNMGN160XXSSNW**

- Outdoor & Indoor use
- Solar + Rechargeable Battery (driver not included)
- Warm Light (included)
- White Light (included)
- RGB Light (included)
- 600 lm
- Remote control (included)

- Dimmable
- Twilight sensor
- 644 L
- Integrated solar panel
- Polyethylene
- Packaging: Plastic bag
- Gross Weight (with packaging): 64kg

**CABLE**

**REF: JDNMGN160XXOFNW**

- Outdoor & Indoor use
- White Light (included)
- 600 lm
- 644 L

- Polyethylene
- Packaging: Plastic bag
- Gross Weight (with packaging): 64kg

## MAGNOLIA 160 | WITHOUT LIGHT BIG SIZE XXL

**OPAQUE COLOUR**

- 2000 L
- Polyethylene
- Packaging: Plastic bag
- Gross Weight (with packaging): 64kg

- White | **REF: JDNMGN160BXNW**
- Black | **REF: JDNMGN160NXNW**
- Bronze | **REF: JDNMGN160ZXNW**
- Anthracite | **REF: JDNMGN160ANNW**

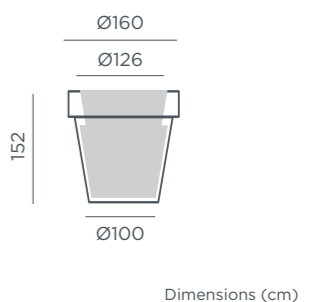
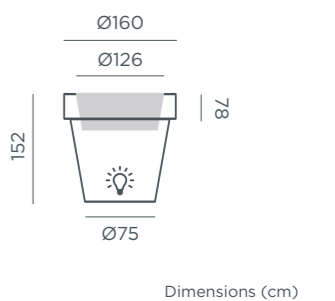



# Melisa 30.



# Melisa 40.



## MELISA 30 | WITH LIGHT

### SOLAR & RECHARGEABLE BATTERY

REF: LUMML030SSNW

- IP65 Outdoor & Indoor use
- Solar + Rechargeable Battery (driver not included)
- Warm Light (included)
- White Light (included)
- RGB Light (included)
- 45 lm
- Remote control (included)

- Dimmable
- Twilight sensor
- 6,7 L
- Integrated solar panel
- Polyethylene
- Packaging: 31 x 31 x 62,3 cm
- Gross Weight (with packaging): 4kg

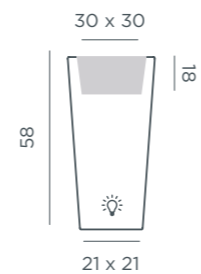

Dimensions (cm)

### CABLE

REF: LUMML030OFNW

- IP65 Outdoor & Indoor use
- White Light (included)
- 600 lm
- 6,7 L

- Polyethylene
- Packaging: 31 x 31 x 62,3 cm
- Gross Weight (with packaging): 4kg

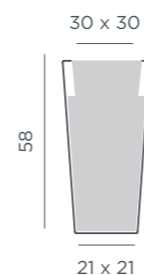

Dimensions (cm)

## MELISA 30 | WITHOUT LIGHT

### OPAQUE COLOUR

- 11 L
- Polyethylene
- Packaging: Plastic bag
- Gross Weight (with packaging): 3,5kg

- White | REF: JDNML030BXNW
- Black | REF: JDNML030NXNW
- Bronze | REF: JDNML030ZXNW
- Taupe | REF: JDNML030KNNW
- Terracota | REF: JDNML030TNNW
- Anthracite | REF: JDNML030ANNW

## MELISA 40 | WITH LIGHT

### SOLAR & RECHARGEABLE BATTERY

REF: LUMML040SSNW

- IP65 Outdoor & Indoor use
- Solar + Rechargeable Battery (driver not included)
- Warm Light (included)
- White Light (included)
- RGB Light (included)
- 45 lm
- Remote control (included)

- Dimmable
- Twilight sensor
- 11,9 L
- Integrated solar panel
- Polyethylene
- Packaging: 40,5 x 40,5 x 89,5 cm
- Gross Weight (with packaging): 7kg

### CABLE

REF: LUMML040OFNW

- IP65 Outdoor & Indoor use
- White Light (included)
- 600 lm
- Led tube lighting (included)

- 11,9 L
- Polyethylene
- Packaging: 40,5 x 40,5 x 89,5 cm
- Gross Weight (with packaging): 7kg

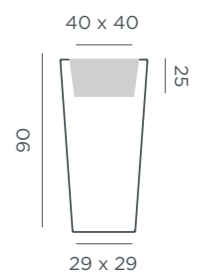

Dimensions (cm)

## MELISA 40 | WITHOUT LIGHT

### OPAQUE COLOUR

- 11,9 L
- Polyethylene
- Packaging: Plastic bag
- Gross Weight (with packaging): 6kg

- White | REF: JDNML040BXNW
- Black | REF: JDNML040NXNW
- Bronze | REF: JDNML040ZXNW
- Anthracite | REF: JDNML040ANNW





# Melisa 50.



## MELISA 50 | WITH LIGHT

### ☀️ + 🔋 SOLAR & RECHARGEABLE BATTERY

REF: LUMML050SSNW

- IP65 Outdoor & Indoor use
- ☀️ Solar + Rechargeable Battery (driver not included)
- 💡 Warm Light (included)
- 💡 White Light (included)
- 💡 RGB Light (included)
- lm 45 lm
- 📶 Remote control (included)

- 📶 Dimmable
- 🌙 Twilight sensor
- 💧 13,9 L
- ☀️ Integrated solar panel
- M Polyethylene
- 📦 Packaging: 50 x 50 x 110 cm
- 📦 Gross Weight (with packaging): 11kg

### 🔌 CABLE

REF: LUMML0500FNW

- IP65 Outdoor & Indoor use
- 💡 White Light (included)
- lm 600 lm
- 💡 Led tube lighting (included)

- 💧 13,9 L
- M Polyethylene
- 📦 Packaging: 50 x 50 x 111 cm
- 📦 Gross Weight (with packaging): 11kg

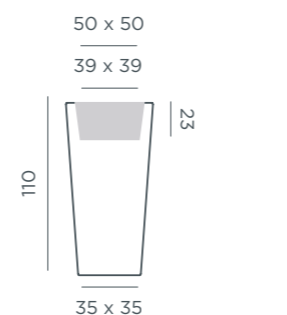

Dimensions (cm)

## MELISA 50 | WITHOUT LIGHT

### OPAQUE COLOUR

- 💧 13,9 L
- M Polyethylene
- 📦 Packaging: 50 x 50 x 111 cm
- 📦 Gross Weight (with packaging): 10kg

- White | ○ REF: JDNML050BXNW
- Black | ● REF: JDNML050NXNW
- Bronze | ● REF: JDNML050ZXNW
- Anthracite | ● REF: JDNML050ANNW

# Palma.

## PALMA 70

### ☀️ + 🔋 SOLAR & RECHARGEABLE BATTERY

REF: LUMPM070SSNW

- IP65 Outdoor & Indoor use
- ☀️ Solar + Rechargeable Battery (driver not included)
- 💡 Warm Light (included)
- 💡 White Light (included)
- 💡 RGB Light (included)
- lm 45 lm
- 📶 Remote control (included)

- 📶 Dimmable
- 🌙 Twilight sensor
- 💧 9,1 L
- ☀️ Integrated solar panel
- M Polyethylene
- 📦 Packaging: 35,5 x 35,5 x 70 cm
- 📦 Gross Weight (with packaging): 4,5kg

### 🔌 CABLE

REF: LUMPM0700FNW

- IP65 Outdoor & Indoor use
- 💡 White Light (included)
- lm 600 lm
- 💧 9,1 L

- M Polyethylene
- 📦 Packaging: 35,5 x 35,5 x 70 cm
- 📦 Gross Weight (with packaging): 4,5kg

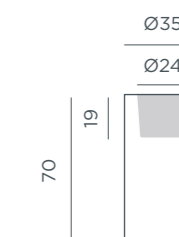

Dimensions (cm)





# Ficus 60 & Ficus 80

## FICUS 60 | WITH LIGHT

SOLAR & RECHARGEABLE BATTERY

REF: LUMFC060SSNW

- IP65 Outdoor & Indoor use
- Solar + Rechargeable Battery (driver not included)
- Warm Light (included)
- White Light (included)
- RGB Light (included)
- lm 45 lm
- Remote control (included)

- Dimmable
- Twilight sensor
- 9 L
- Integrated solar panel
- Polyethylene
- Packaging: 29,4 x 29,4 x 59,5 cm
- Gross Weight (with packaging): 2,98kg

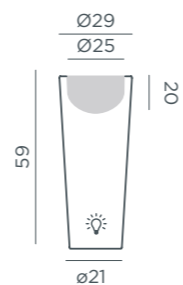

Dimensions (cm)

CABLE

REF: LUMFC060OFNW

- IP65 Outdoor & Indoor use
- White Light (included)
- lm 600 lm
- 9 L

- Polyethylene
- Packaging: 29,4 x 29,4 x 59,5 cm
- Gross Weight (with packaging): 2,6kg

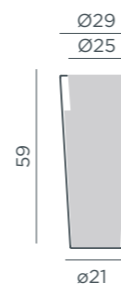

Dimensions (cm)

## FICUS 60 | WITHOUT LIGHT

OPAQUE COLOUR

- 16,1 L
- Polyethylene
- Packaging: Plastic bag
- Gross Weight (with packaging): 2,1kg

- White | REF: JDNFC060BXNW
- Black | REF: JDNFC060NXNW
- Bronze | REF: JDNFC060ZXNW
- Anthracite | REF: JDNFC060ANNW

## FICUS 80 | WITH LIGHT

SOLAR & RECHARGEABLE BATTERY

REF: LUMFC080SSNW

- IP65 Outdoor & Indoor use
- Solar + Rechargeable Battery (driver not included)
- Warm Light (included)
- White Light (included)
- RGB Light (included)
- lm 45 lm
- Remote control (included)

- Dimmable
- Twilight sensor
- 9,5 L
- Integrated solar panel
- Polyethylene
- Packaging: 29,5 x 29,5 x 80 cm
- Gross Weight (with packaging): 3,2kg

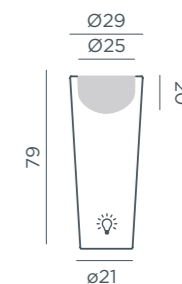

Dimensions (cm)

CABLE

REF: LUMFC080OFNW

- IP65 Outdoor & Indoor use
- White Light (included)
- lm 600 lm
- 9,5 L

- Polyethylene
- Packaging: 29,5 x 29,5 x 80 cm
- Gross Weight (with packaging): 3,2kg

## FICUS 80 | WITHOUT LIGHT

OPAQUE COLOUR

- 22,5 L
- Polyethylene
- Packaging: Plastic bag
- Gross Weight (with packaging): 2,7kg

- White | REF: JDNFC080BXNW
- Black | REF: JDNFC080NXNW
- Bronze | REF: JDNFC080ZXNW
- Anthracite | REF: JDNFC080ANNW

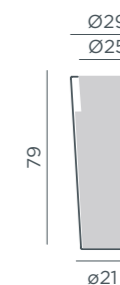

Dimensions (cm)





# Bambú 70.



# Bambú 90.

## BAMBU 70 | WITH LIGHT

### RECHARGEABLE BATTERY

REF: LUMBM070WLNW

- IP65 Outdoor & Indoor use
- Rechargeable Battery Electric Charge (driver not included)
- White Light (included)
- RGB Light (included)
- 315 lm
- Remote control (included)
- Dimmable

- Led tube lighting (included)
- 15,8 L
- Integrated solar panel
- M Polyethylene
- Packaging: 40 x 40 x 70 cm
- Gross Weight (with packaging): 4,5kg

### CABLE

REF: LUMBM070OFNW

- IP65 Outdoor & Indoor use
- White Light (included)
- 600 lm
- 15,8L

- M Polyethylene
- Packaging: 40 x 40 x 70 cm
- Gross Weight (with packaging): 4,5kg

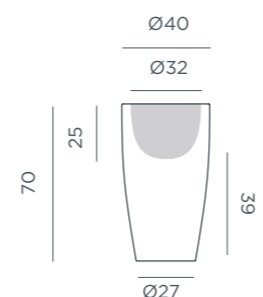

Dimensions (cm)

## BAMBU 70 | WITHOUT LIGHT

### OPAQUE COLOUR

- 15,8 L
- M Polyethylene
- Packaging: 40 x 40 x 70
- Gross Weight (with packaging): 4kg

- White | ○ REF: JDNBM070BXNW
- Black | ● REF: JDNBM070NXNW
- Bronze | ● REF: JDNBM070ZXNW
- Terracota | ● REF: JDNBM070TXNW
- Anthracite | ● REF: JDNBM070ANNW

## BAMBU 90 | WITH LIGHT

### RECHARGEABLE BATTERY

REF: LUMBM090TWNW

- IP65 Outdoor & Indoor use
- Rechargeable Battery Electric Charge (driver not included)
- White Light (included)
- RGB Light (included)
- 335 lm
- Remote control (included)
- Dimmable

- Led tube lighting (included)
- 15,8 L
- Integrated solar panel
- M Polyethylene
- Packaging: 40 x 40 x 90 cm
- Gross Weight (with packaging): 6,5kg

### CABLE

REF: LUMBM090OFNW

- IP65 Outdoor & Indoor use
- White Light (included)
- 900 lm
- Led tube lighting (included)

- 15,8L
- M Polyethylene
- Packaging: 40 x 40 x 90 cm
- Gross Weight (with packaging): 6,5kg

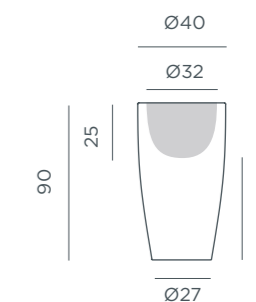

Dimensions (cm)

## BAMBU 90 | WITHOUT LIGHT

### OPAQUE COLOUR

- 15,8 L
- M Polyethylene
- Packaging: 40 x 40 x 90 cm
- Gross Weight (with packaging): 6kg

- White | ○ REF: JDNBM090BXNW
- Black | ● REF: JDNBM090NXNW
- Bronze | ● REF: JDNBM090ZXNW
- Terracota | ● REF: JDNBM090TXNW
- Anthracite | ● REF: JDNBM090ANNW



# Junco.



## JUNCO 80 | WITH LIGHT

### ☀️ + 🔋 SOLAR & RECHARGEABLE BATTERY

REF: LUMJN0800SSNW

- IP65 Outdoor & Indoor use
- ☀️ Solar + Rechargeable Battery (driver not included)
- 💡 Warm Light (included)
- 💡 White Light (included)
- 💡 RGB Light (included)
- lm 45 lm
- 📶 Remote control (included)

- 📶 Dimmable
- 🌙 Twilight sensor
- 💧 38,8 L
- ☀️ Integrated solar panel
- M Polyethylene
- 📦 Packaging: 38 x 84 x 82,7cm
- 📦 Gross Weight (with packaging): 12kg

### 🔌 CABLE

REF: LUMJN0800FNW

- IP65 Outdoor & Indoor use
- 💡 White Light (included)
- lm 600 lm
- 💧 38,8 L

- M Polyethylene
- 📦 Packaging: 38 x 84 x 82,7 cm
- 📦 Gross Weight (with packaging): 12kg

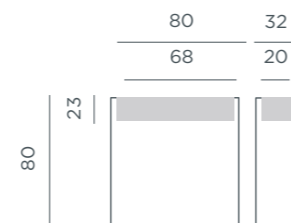

Dimensions (cm)

## JUNCO 80 | WITHOUT LIGHT

### OPAQUE COLOUR

- 💧 38,8 L
- M Polyethylene
- 📦 Packaging: Plastic bag
- 📦 Gross Weight (with packaging): 10kg

- White | ○ REF: JDNJN080BXNW
- Black | ● REF: JDNJN080NXNW
- Bronze | ● REF: JDNJN080ZXNW
- Taupe | ● REF: JDNJN080KXNW
- Anthracite | ● REF: JDNJN080ANNW

# Jara Collection.



## JARA 60X20

- 💧 12,4 L
- M Polyethylene
- 📦 Packaging: Plastic bag
- 📦 Gross Weight (with packaging): 1,5kg

- White | ○ REF: JDNJR060BXNW
- Black | ● REF: JDNJR060NXNW
- Bronze | ● REF: JDNJR060ZXNW
- Taupe | ● REF: JDNJR060KXNW
- Terracota | ● REF: JDNJR060TXNW
- Anthracite | ● REF: JDNJR060ANNW

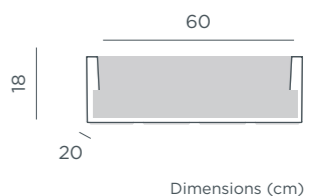

Dimensions (cm)

## JARA 100X35

- 💧 51,7 L
- 🌊 Includes water reservoir
- M Polyethylene
- 📦 Packaging: Plastic bag
- 📦 Gross Weight (with packaging): 7kg

- White | ○ REF: JDNJR100BXNW
- Black | ● REF: JDNJR100NXNW
- Bronze | ● REF: JDNJR100ZXNW
- Taupe | ● REF: JDNJR100KXNW
- Terracota | ● REF: JDNJR100TXNW
- Anthracite | ● REF: JDNJR100ANNW

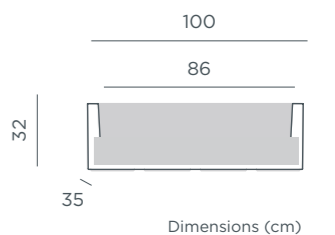

Dimensions (cm)

## JARA 100X40

- 💧 60,7 L
- 🌊 Includes water reservoir
- M Polyethylene
- 📦 Packaging: Plastic bag
- 📦 Gross Weight (with packaging): 8kg

- White | ○ REF: JDNJR140BXNW
- Black | ● REF: JDNJR140NXNW
- Bronze | ● REF: JDNJR140ZXNW
- Taupe | ● REF: JDNJR140KXNW
- Terracota | ● REF: JDNJR140TXNW
- Anthracite | ● REF: JDNJR140ANNW

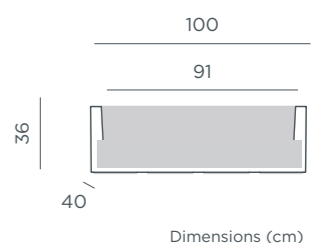

Dimensions (cm)



# Narciso Collection.

## NARCISO 40 | WITH LIGHT

SOLAR & RECHARGEABLE BATTERY

REF: LUMNC040SSNW

- IP65 Outdoor & Indoor use
- Solar + Rechargeable Battery (driver not included)
- Warm Light (included)
- White Light (included)
- RGB Light (included)
- lm 45 lm
- Remote control (included)

- Dimmable
- Twilight sensor
- 15,3 L
- Integrated solar panel
- Polyethylene
- Packaging: 40,5 x 40,5 x 40 cm
- Gross Weight (with packaging): 3,5kg

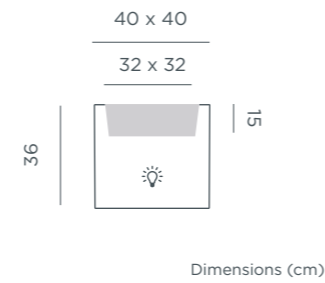

## NARCISO 40 | WITHOUT LIGHT

OPAQUE COLOUR

- 27,8 L
- Includes water reservoir
- Polyethylene
- Packaging: Plastic bag
- Gross Weight (with packaging): 2,5kg

- White | REF: JDNNC040BXNW
- Black | REF: JDNNC040NXNW
- Bronze | REF: JDNNC040ZXNW
- Terracota | REF: JDNNC040TXNW
- Anthracite | REF: JDNNC040ANNW

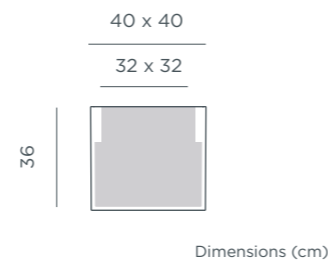

## NARCISO 50 | WITH LIGHT

SOLAR & RECHARGEABLE BATTERY

REF: LUMNC050SSNW

- IP65 Outdoor & Indoor use
- Solar + Rechargeable Battery (driver not included)
- Warm Light (included)
- White Light (included)
- RGB Light (included)
- lm 45 lm
- Remote control (included)

- Dimmable
- Twilight sensor
- 33 L
- Integrated solar panel
- Polyethylene
- Packaging: 59 x 59 x 59 cm
- Gross Weight (with packaging): 6,5kg

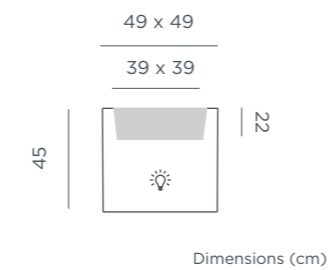

## NARCISO 50 | WITHOUT LIGHT

OPAQUE COLOUR

- 53,8 L
- Includes water reservoir
- Polyethylene
- Packaging: Plastic bag
- Gross Weight (with packaging): 5kg

- White | REF: JDNNC050BXNW
- Black | REF: JDNNC050NXNW
- Bronze | REF: JDNNC050ZXNW
- Terracota | REF: JDNNC050TXNW
- Anthracite | REF: JDNNC050ANNW

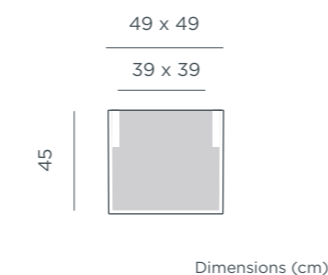

## NARCISO 35

- 17,4 L
- Polyethylene
- Packaging: Plastic bag
- Gross Weight (with packaging): 2kg

- White | REF: JDNNC035BXNW
- Black | REF: JDNNC035NXNW
- Bronze | REF: JDNNC035ZXNW
- Taupe | REF: JDNNC035KXNW
- Terracota | REF: JDNNC035TXNW
- Anthracite | REF: JDNNC035ANNW

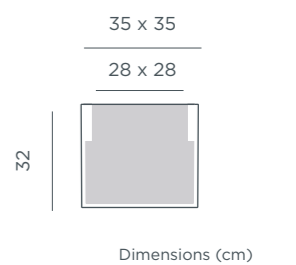

## NARCISO 60

- 84,8 L
- Polyethylene
- Packaging: Plastic bag
- Gross Weight (with packaging): 7kg

- White | REF: JDNNC060BXNW
- Black | REF: JDNNC060NXNW
- Bronze | REF: JDNNC060ZXNW
- Anthracite | REF: JDNNC060ANNW

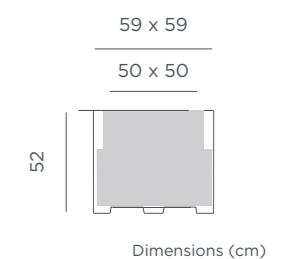



# Gerbera.

GERBERA 33



GERBERA 45

GERBERA 50



# Camelia Collection.

## GERBERA 33

- 🍷 19,6 L
- 🌿 Includes water reservoir
- M** Polyethylene
- 📦 Packaging: Plastic bag
- 📦 Gross Weight (with packaging): 1,2kg

- White | ○ REF: JDNGB033BXNW
- Black | ● REF: JDNGB033NXNW
- Bronze | ● REF: JDNGB033ZXNW
- Taupe | ● REF: JDNGB033KXNW
- Terracota | ● REF: JDNGB033TXNW
- Anthracite | ● REF: JDNGB033ANNW

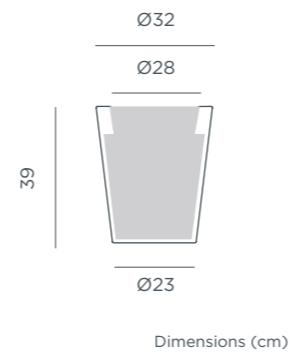

## GERBERA 45

- 🍷 54,8 L
- 🌿 Includes water reservoir
- M** Polyethylene
- 📦 Packaging: Plastic bag
- 📦 Gross Weight (with packaging): 2,5kg

- White | ○ REF: JDNGB045BXNW
- Black | ● REF: JDNGB045NXNW
- Bronze | ● REF: JDNGB045ZXNW
- Taupe | ● REF: JDNGB045KXNW
- Terracota | ● REF: JDNGB045TXNW
- Anthracite | ● REF: JDNGB045ANNW

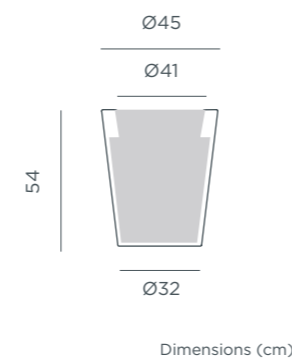

## GERBERA 50 | RUSTIC TEXTURE

- 🍷 72,8 L
- 🌿 Includes water reservoir
- M** Polyethylene
- 📦 Packaging: Plastic bag
- 📦 Gross Weight (with packaging): 4kg

- White | ○ REF: JDNGB050BXNW
- Black | ● REF: JDNGB050NXNW
- Bronze | ● REF: JDNGB050ZXNW
- Terracota | ● REF: JDNGB050TXNW
- Anthracite | ● REF: JDNGB050ANNW

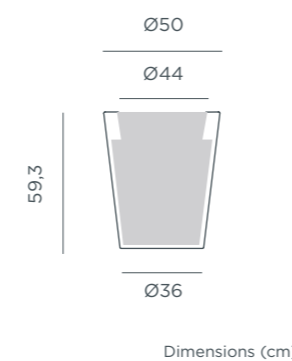





# Camelia 40.



# Camelia 60.

## CAMELIA 40 | WITH LIGHT

### SOLAR & RECHARGEABLE BATTERY

REF: LUMCA040SSNW

- IP65 Outdoor & Indoor use
- Rechargeable Battery Electric Charge (driver not included)
- Warm Light (included)
- White Light (included)
- RGB Light (included)
- Im 45 lm
- Remote control (included)

- Dimmable
- Twilight sensor
- 5,5 L
- Integrated solar panel
- M Polyethylene
- Packaging: 40,5 x 40,5 x 39,5 cm
- Gross Weight (with packaging): 3,5kg

### CABLE

REF: LUMCA040OFNW

- IP65 Outdoor & Indoor use
- White Light (included)
- Im 600 lm
- 5,5 L

- M Polyethylene
- Packaging: 40,5 x 40,5 x 39,5 cm
- Gross Weight (with packaging): 3,2kg

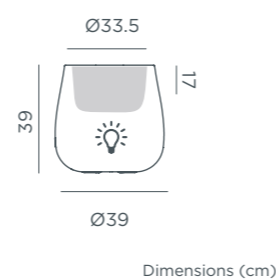

## CAMELIA 40 | WITHOUT LIGHT

### OPAQUE COLOUR

- 32,45 L
- M Polyethylene
- Packaging: Plastic bag
- Gross Weight (with packaging): 2,2kg

- White | ○ REF: JDNCA040BXNW
- Black | ● REF: JDNCA040NXNW
- Bronze | ● REF: JDNCA040ZXNW
- Anthracite | ● REF: JDNCA040ANNW

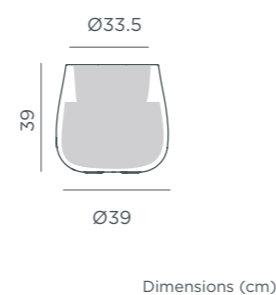

## CAMELIA 40 | CIRCOOLAR



Recycled Multicolour | REF: LUMCML040BXNLCR

- 32,45 L
- M Recycled detergent bottles
- Packaging: Plastic bag
- Gross Weight (with packaging): 2,2kg

Made of recycled detergent bottles

## CAMELIA 40 | CIRCOOLAR



Recycled Blue | REF: LUMCML040AZNLCR

- 32,45 L
- M Recycled fishing nets
- Packaging: Plastic bag
- Gross Weight (with packaging): 2,2kg

Made of recycled fishing nets

## CAMELIA 60 | WITH LIGHT

### SOLAR & RECHARGEABLE BATTERY

REF: LUMCA060SSNW

- IP65 Outdoor & Indoor use
- Solar + Rechargeable Battery (driver not included)
- Warm Light (included)
- White Light (included)
- RGB Light (included)
- Im 45 lm
- Remote control (included)

- Dimmable
- Twilight sensor
- 29,4 L
- Integrated solar panel
- M Polyethylene
- Packaging: 60,5 x 60,5 x 42,7 cm
- Gross Weight (with packaging): 5kg

### CABLE

REF: LUMCA060OFNW

- IP65 Outdoor & Indoor use
- White Light (included)
- Im 600 lm
- 29,4 L

- M Polyethylene
- Packaging: 60 x 60 x 42 cm
- Gross Weight (with packaging): 5kg

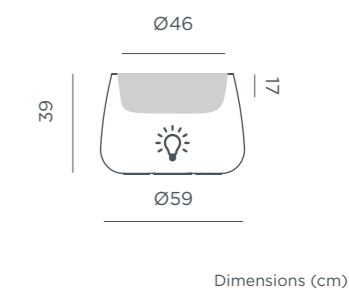

## CAMELIA 60 | WITHOUT LIGHT

### OPAQUE COLOUR

- 74 L
- M Polyethylene
- Packaging: Plastic bag
- Gross Weight (with packaging): 4,5kg

- White | ○ REF: JDNCA060BXNW
- Black | ● REF: JDNCA060NXNW
- Bronze | ● REF: JDNCA060ZXNW
- Anthracite | ● REF: JDNCA060ANNW

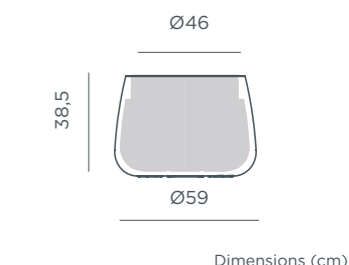

## CAMELIA 60 | CIRCOOLAR



Recycled Multicolour | REF: LUMCML060BXNLCR

- 74 L
- M Recycled detergent bottles
- Packaging: Plastic bag
- Gross Weight (with packaging): 4,5kg

Made of recycled detergent bottles

## CAMELIA 60 | CIRCOOLAR



Recycled Blue | REF: LUMCML060AZNLCR

- 74 L
- M Recycled fishing nets
- Packaging: Plastic bag
- Gross Weight (with packaging): 4,5kg

Made of recycled fishing nets



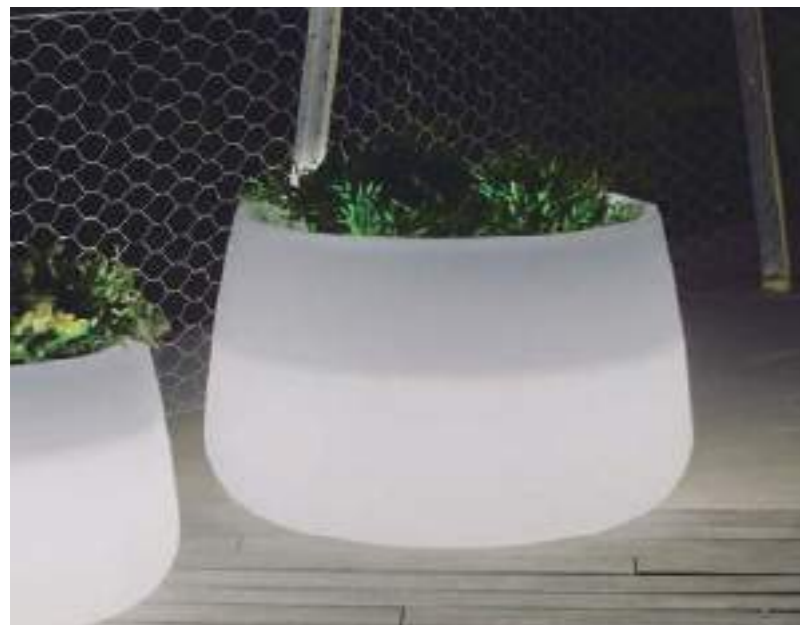

# Camelia 80.



# Camelia large.

## CAMELIA 80 | WITH LIGHT

SOLAR & RECHARGEABLE BATTERY

REF: LUMCA080SSNW

- IP65 Outdoor & Indoor use
- Solar + Rechargeable Battery (driver not included)
- Warm Light (included)
- White Light (included)
- RGB Light (included)
- Im 45 lm
- Remote control (included)

- Dimmable
- Twilight sensor
- 74,8 L
- Integrated solar panel
- M** Polyethylene
- Packaging: Plastic bag
- Gross Weight (with packaging): 10,5kg

CABLE

REF: LUMCA080OFNW

- IP65 Outdoor & Indoor use
- White Light (included)
- Im 600 lm
- 74,8 L

- M** Polyethylene
- Packaging: Plastic bag
- Gross Weight (with packaging): 10,5kg

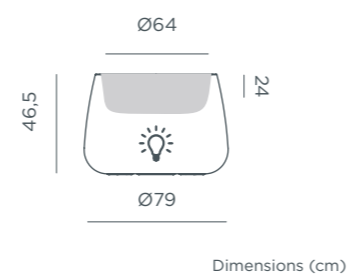

## CAMELIA 80 | WITHOUT LIGHT

OPAQUE COLOUR

- 178,4 L
- M** Polyethylene
- Packaging: Plastic bag
- Gross Weight (with packaging): 10kg

- White | REF: JDNCA080BXNW
- Black | REF: JDNCA080NXNW
- Bronze | REF: JDNCA080ZXNW
- Anthracite | REF: JDNCA080ANNW

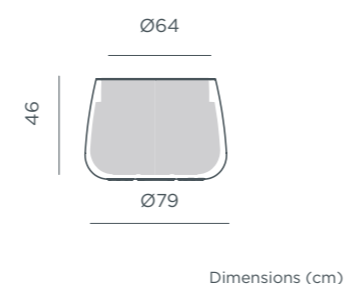

## CAMELIA 80 | CIRCOOLAR

Recycled Multicolour | REF: LUMCML080BXNLCR

- 178,4 L
- M** Recycled detergent bottles
- Packaging: Plastic bag
- Gross Weight (with packaging): 10kg

Made of recycled detergent bottles

## CAMELIA 80 | CIRCOOLAR

Recycled Blue | REF: LUMCML080AZNLCR

- 178,4 L
- M** Recycled fishing nets
- Packaging: Plastic bag
- Gross Weight (with packaging): 10kg

Made of recycled fishing nets

## CAMELIA LARGE | WITH LIGHT

SOLAR & RECHARGEABLE BATTERY

REF: LUMCALARSSNW

- IP65 Outdoor & Indoor use
- Solar + Rechargeable Battery (driver not included)
- Warm Light (included)
- White Light (included)
- RGB Light (included)
- Im 45 lm
- Remote control (included)

- Dimmable
- Twilight sensor
- 43,4 L
- Integrated solar panel
- M** Polyethylene
- Packaging: 50 x 111 x 50 cm
- Gross Weight (with packaging): 7,5kg

CABLE

REF: LUMCALAROFNW

- IP65 Outdoor & Indoor use
- White Light (included)
- Im 600 lm
- 43,4 L

- M** Polyethylene
- Packaging: 50 x 111 X 50 cm
- Gross Weight (with packaging): 7,5kg

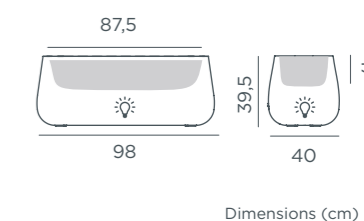

## CAMELIA LARGE | WITHOUT LIGHT

OPAQUE COLOUR

- 101,6 L
- M** Polyethylene
- Packaging: Plastic bag
- Gross Weight (with packaging): 6kg

- White | REF: JDNCALARBXNW
- Black | REF: JDNCALARNXNW
- Bronze | REF: JDNCALARZXNW
- Anthracite | REF: JDNCALARANNW

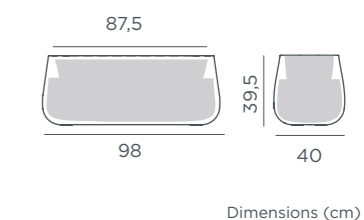

## CAMELIA LARGE | CIRCOOLAR

Recycled Multicolour | REF: LUMCLG100BXNLCR

- 101,6 L
- M** Recycled detergent bottles
- Packaging: Plastic bag
- Gross Weight (with packaging): 6kg

Made of recycled detergent bottles

## CAMELIA LARGE | CIRCOOLAR

Recycled Blue | REF: LUMCLG100AZNLCR

- 101,6 L
- M** Recycled fishing nets
- Packaging: Plastic bag
- Gross Weight (with packaging): 6kg

Made of recycled fishing nets





# Camelia high.

## CAMELIA HIGH | WITH LIGHT

**SOLAR & RECHARGEABLE BATTERY**

**REF: LUMCAHIGSSNW**

- Outdoor & Indoor use
- Solar + Rechargeable Battery (driver not included)
- Warm Light (included)
- White Light (included)
- RGB Light (included)
- 45 lm
- Remote control (included)

- Dimmable
- Twilight sensor
- 14 L
- Integrated solar panel
- Polyethylene
- Packaging: 40,5 x 40,5 x 69,5 cm
- Gross Weight (with packaging): 4kg

**CABLE**

**REF: LUMCAHIGOFNW**

- Outdoor & Indoor use
- White Light (included)
- 600 lm
- 14 L

- Polyethylene
- Packaging: Plastic bag
- Gross Weight (with packaging): 4kg

## CAMELIA HIGH | WITHOUT LIGHT

**OPAQUE COLOUR**

- 53,7 L
- Polyethylene
- Packaging: Plastic bag
- Gross Weight (with packaging): 3,5kg

- White | **REF: JDNCAHIGBXNW**
- Black | **REF: JDNCAHIGNXNW**
- Bronze | **REF: JDNCAHIGZXNW**
- Anthracite | **REF: JDNCAHIGANNW**

## CAMELIA HIGH | CIRCOOLAR

Recycled Multicolour | **REF: LUMCMH040BXNLCR**

- 53,7 L
- Recycled detergent bottles
- Packaging: Plastic bag
- Gross Weight (with packaging): 3,5kg

**Made of recycled detergent bottles**

## CAMELIA HIGH | CIRCOOLAR

Recycled Blue | **REF: LUMCMH040AZNLCR**

- 53,7 L
- Recycled fishing nets
- Packaging: Plastic bag
- Gross Weight (with packaging): 3,5kg

**Made of recycled fishing nets**

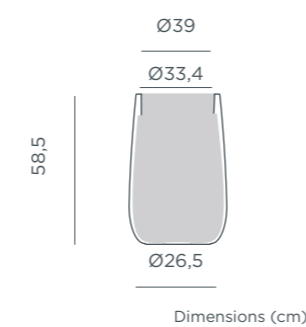
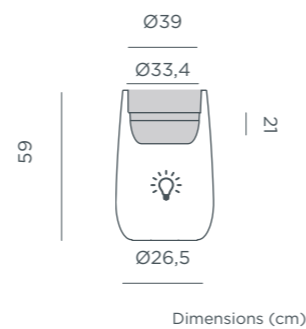



# Jazmín.



## JAZMÍN 60

- 💧 21,5 L
- 🌿 Includes water reservoir
- M** Polyethylene
- 📦 Packaging: Plastic bag
- 📦 Gross Weight (with packaging): 2kg

- White | ○ REF: JDNJZ060BXNW
- Black | ● REF: JDNJZ060NXNW
- Bronze | ● REF: JDNJZ060ZXNW
- Terracota | ● REF: JDNJZ060TXNW
- Anthracite | ● REF: JDNJZ060ANNW

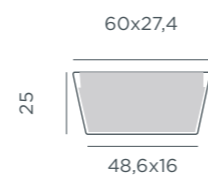

Dimensions (cm)

## JAZMÍN 80

- 💧 58,7 L
- 🌿 Includes water reservoir
- M** Polyethylene
- 📦 Packaging: Plastic bag
- 📦 Gross Weight (with packaging): 4kg

- White | ○ REF: JDNJZ080BXNW
- Black | ● REF: JDNJZ080NXNW
- Bronze | ● REF: JDNJZ080ZXNW
- Terracota | ● REF: JDNJZ080TXNW
- Anthracite | ● REF: JDNJZ080ANNW

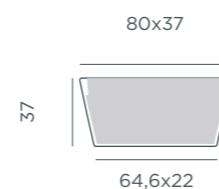

Dimensions (cm)

# Clavel.



## CLAVEL 30

- 💧 5,2 L
- M** Polyethylene
- 📦 Packaging: Plastic bag
- 📦 Gross Weight (with packaging): 1,2kg

- White | ○ REF: JDNCV030BXNW
- Black | ● REF: JDNCV030NXNW
- Bronze | ● REF: JDNCV030ZXNW
- Taupe | ● REF: JDNCV030KXNW
- Terracota | ● REF: JDNCV030TXNW
- Anthracite | ● REF: JDNCV030ANNW



Dimensions (cm)

## CLAVEL 40

- 💧 12,3 L
- M** Polyethylene
- 📦 Packaging: Plastic bag
- 📦 Gross Weight (with packaging): 2,5kg

- White | ○ REF: JDNCV040BXNW
- Black | ● REF: JDNCV040NXNW
- Bronze | ● REF: JDNCV040ZXNW
- Terracota | ● REF: JDNCV040TXNW
- Anthracite | ● REF: JDNCV040ANNW



Dimensions (cm)



## VIOLETA 30

- 12,5 L
- Includes water reservoir
- M Polyethylene
- Packaging: Plastic bag
- Gross Weight (with packaging): 1kg

- White | ○ REF: JDNVLO30BXNW
- Black | ● REF: JDNVLO30NXNW
- Bronze | ● REF: JDNVLO30ZXNW
- Taupe | ● REF: JDNVLO30KXNW
- Terracota | ● REF: JDNVLO30TXNW
- Anthracite | ● REF: JDNVLO30ANNW

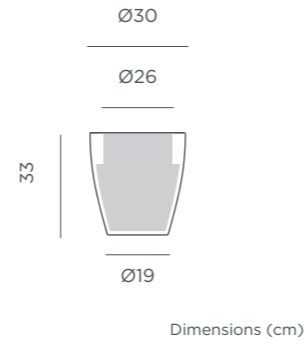

## VIOLETA 40 | WITH LIGHT

**SOLAR & RECHARGEABLE BATTERY**

REF: LUMVLO40SSNW

- IP65 Outdoor & Indoor use
- Solar + Rechargeable Battery (driver not included)
- Warm Light (included)
- White Light (included)
- RGB Light (included)
- Im 45 lm
- Remote control (included)

- Dimmable
- Twilight sensor
- 14,5 L
- Integrated solar panel
- M Polyethylene
- Packaging: 46 x 46 x 46,5 cm
- Gross Weight (with packaging): 3kg

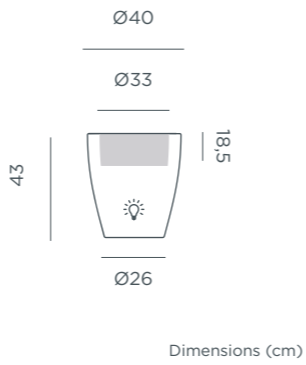

## VIOLETA 40 | WITHOUT LIGHT

**OPAQUE COLOUR**

- 30,6 L
- Includes water reservoir
- M Polyethylene
- Packaging: Plastic bag
- Gross Weight (with packaging): 2kg

- White | ○ REF: JDNVLO40BXNW
- Black | ● REF: JDNVLO40NXNW
- Bronze | ● REF: JDNVLO40ZXNW
- Taupe | ● REF: JDNVLO40KXNW
- Terracota | ● REF: JDNVLO40TXNW
- Anthracite | ● REF: JDNVLO40ANNW

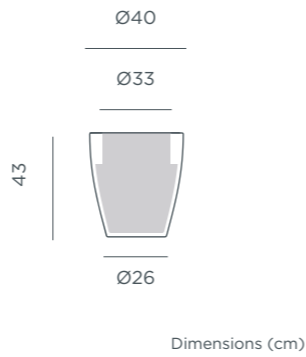

## VIOLETA 55 | WITH LIGHT

**SOLAR & RECHARGEABLE BATTERY**

REF: LUMVLO55SSNW

- IP65 Outdoor & Indoor use
- Rechargeable Battery Electric Charge (driver not included)
- Warm Light (included)
- White Light (included)
- RGB Light (included)
- Im 45 lm
- Remote control (included)

- Dimmable
- Twilight sensor
- 34,7 L
- Integrated solar panel
- M Polyethylene
- Packaging: 59 x 59 x 59 cm
- Gross Weight (with packaging): 5,5kg

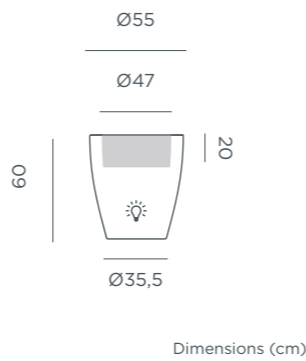

## VIOLETA 55 | WITHOUT LIGHT

**OPAQUE COLOUR**

- 68,2 L
- Includes water reservoir
- M Polyethylene
- Packaging: Plastic bag
- Gross Weight (with packaging): 4kg

- White | ○ REF: JDNVLO55BXNW
- Black | ● REF: JDNVLO55NXNW
- Bronze | ● REF: JDNVLO55ZXNW
- Terracota | ● REF: JDNVLO55TXNW
- Anthracite | ● REF: JDNVLO55ANNW

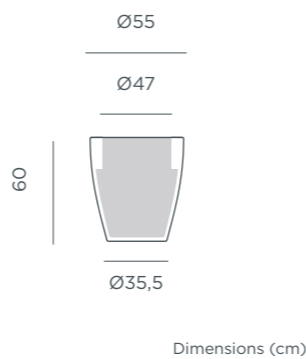

VIOLETA 55 | 40 | 30



# Girasol.



## GIRASOL BIG SIZE XXL

- 313 L
- M Polyethylene
- Packaging: Plastic bag
- Gross Weight (with packaging): 14kg

- White | ○ REF: JDNGL090BXNW
- Black | ● REF: JDNGL090NXNW
- Bronze | ● REF: JDNGL090ZXNW
- Terracota | ● REF: JDNGL090TXNW
- Anthracite | ● REF: JDNGL090ANNW



Dimensions (cm)

## CALÉNDULA RÚSTICA

- 49,7 L
- M Polyethylene
- Packaging: Plastic bag
- Gross Weight (with packaging): 6kg

- White | ○ REF: JDNCL050BXNW
- Black | ● REF: JDNCL050NXNW
- Bronze | ● REF: JDNCL050ZXNW
- Terracota | ● REF: JDNCL050TXNW
- Anthracite | ● REF: JDNCL050ANNW

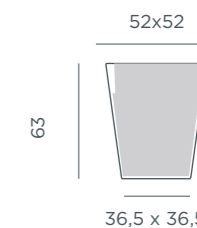

Dimensions (cm)













# Camomila.

# Petunia.



## CAMOMILA RÚSTICA





-  44 L
-  Polyethylene
-  Packaging: Plastic bag
-  Gross Weight (with packaging): 2.5kg







- White |  REF: JDNCM040BXNW
- Black |  REF: JDNCM040NXNW
- Bronze |  REF: JDNCM040ZXNW
- Taupe |  REF: JDNCM040KXNW
- Terracota |  REF: JDNCM040TXNW
- Anthracite |  REF: JDNCM040ANNW



Dimensions (cm)

## PETUNIA RÚSTICA

-  17,3 L
-  Polyethylene
-  Packaging: Plastic bag
-  Gross Weight (with packaging): 1kg

- White |  REF: JDNPT036BXNW
- Black |  REF: JDNPT036NXNW
- Bronze |  REF: JDNPT036ZXNW
- Taupe |  REF: JDNPT036KXNW
- Terracota |  REF: JDNPT036TXNW
- Anthracite |  REF: JDNPT036ANNW

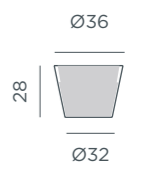

Dimensions (cm)



# Rosa.

## ROSA 45

- 🍷 26 L
- M** Polyethylene
- 📦 Packaging: Plastic bag
- 📦 Gross Weight (with packaging): 1.5kg

- White | ○ **REF: JDNRS045BXNW**
- Black | ● **REF: JDNRS045NXNW**
- Bronze | ● **REF: JDNRS045ZXNW**
- Terracota | ● **REF: JDNRS045TXNW**
- Anthracite | ● **REF: JDNRS045ANNW**

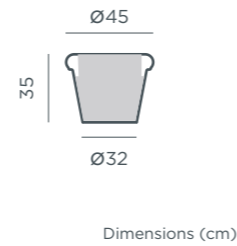

## ROSA 55

- 🍷 42,8 L
- M** Polyethylene
- 📦 Packaging: Plastic bag
- 📦 Gross Weight (with packaging): 2.3kg

- White | ○ **REF: JDNRS055BXNW**
- Black | ● **REF: JDNRS055NXNW**
- Bronze | ● **REF: JDNRS055ZXNW**
- Terracota | ● **REF: JDNRS055TXNW**
- Anthracite | ● **REF: JDNRS055ANNW**

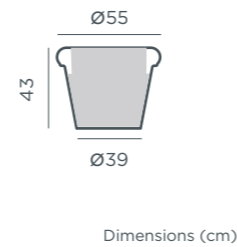

## ROSA 65

- 🍷 79 L
- M** Polyethylene
- 📦 Packaging: Plastic bag
- 📦 Gross Weight (with packaging): 3kg

- White | ○ **REF: JDNRS065BXNW**
- Black | ● **REF: JDNRS065NXNW**
- Bronze | ● **REF: JDNRS065ZXNW**
- Terracota | ● **REF: JDNRS065TXNW**
- Anthracite | ● **REF: JDNRS065ANNW**

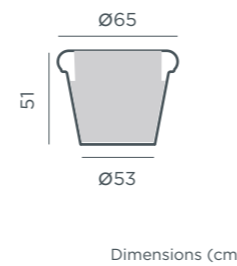

## ROSA 75

- 🍷 121 L
- M** Polyethylene
- 📦 Packaging: Plastic bag
- 📦 Gross Weight (with packaging): 5kg

- White | ○ **REF: JDNRS075BXNW**
- Black | ● **REF: JDNRS075NXNW**
- Bronze | ● **REF: JDNRS075ZXNW**
- Tupe | ● **REF: JDNRS075KXNW**
- Terracota | ● **REF: JDNRS075TXNW**
- Anthracite | ● **REF: JDNRS075ANNW**





# Plates.

## ROUNDED PLATE 30

Compatible with: Violeta 40, Magnolia 45, Rosa 45, Bambú 90, Petunia 30, Hortensia 30, Ficus 60, Ficus 80.

- REF: JDNPRO30BXNW
- REF: JDNPRO30XNW
- REF: JDNPRO30ZXNW
- REF: JDNPRO30KXNW
- REF: JDNPRO30TXNW
- REF: JDNPRO30ANNW

31.5x31.5



Ø37

Dimensions (cm)

## ROUNDED PLATE 40

Compatible with: Violeta 55, Magnolia 60, Rosa 55, Gerbera 45, Azalea 50, Hortensia 40, Hortensia 40 High.

- REF: JDNPRO40BXNW
- REF: JDNPRO40XNW
- REF: JDNPRO40ZXNW
- REF: JDNPRO40KXNW
- REF: JDNPRO40TXNW
- REF: JDNPRO40ANNW

41x41



Ø49

Dimensions (cm)

## SQUARED PLATE 40

Compatible with: Caléndula 50, Melisa 50, Narciso 35.

- REF: JDNPC040BXNW
- REF: JDNPC040XNW
- REF: JDNPC040ZXNW
- REF: JDNPC040KXNW
- REF: JDNPC040TXNW
- REF: JDNPC040ANNW

40x40



47x47

Dimensions (cm)

## SQUARED PLATE 50

Compatible with: Narciso 50.

- REF: JDNPC050BXNW
- REF: JDNPC050XNW
- REF: JDNPC050ZXNW
- REF: JDNPC050KXNW
- REF: JDNPC050TXNW
- REF: JDNPC050ANNW

52x52



































61.5x61.5

Dimensions (cm)





# Glossary.

White light (included) 	 Artificial plants included
Warm light (included) 	 Cherry bulb included
RGB light (included) 	 Solar panel
Led tube Lighting 	 String
Flame effect led light 	<b>lm</b> Lumens
Remote control 	 Packaging
Dimmable 	 Weight
Touch control 	 Solar + electric charge
Twilight sensor 	 Electric charge
Motion sensor 	 Solar charge
Hanging product 	 AAA bateries
Play music 	 Hardwire
Integrated speaker 	 Cable
Material 	 Jute Cable
Floating, not submersible 	 Magnetic
Floating & submersible 	 Connectable
Planter volume 	<b>IP</b> Indicates the level of protection of the electrical or electronic equipment against the entry of external agents: dust or water
Includes water reservoir 	

# Polyethylene Textures.

	<b>SMOOTH TEXTURE</b> Polyethylene		<b>RUSTIC TEXTURE</b> Polyethylene
---	---------------------------------------	---	---------------------------------------

Newgarden's products made of polyethylene have a visually smooth and softly granulated finish that is very pleasant to the touch.

The rustic finish can be found in a very specific selection of flowerpots.

# Colours & Finishes.

## TRANSLUCENT POLYETHYLENE & ABS

			
<b>WHITE</b> Polyethylene	<b>LIME</b> Polyethylene	<b>RECYCLED BLUE</b> Recycled fishing nets	<b>RECYCLED MULTICOLOUR</b> Recycled detergent bottles

## OPAQUE POLYETHYLENE

					
<b>WHITE</b> Polyethylene	<b>BLACK</b> Polyethylene	<b>BRONZE</b> Polyethylene	<b>TERRACOTTA</b> Polyethylene	<b>TAUPE</b> Polyethylene	<b>ANTHRACITE</b> Polyethylene

## OTHER MATERIALS

					
<b>OPAQUE GLOSSY WHITE</b> ABS	<b>OPAQUE GLOSSY BLACK</b> ABS	<b>OPAQUE WHITE</b> Metal	<b>OPAQUE MINT</b> Metal	<b>OPAQUE BRASS</b> Metal	<b>OPAQUE ROSE GOLD</b> Metal
					
<b>OPAQUE LIME</b> Metal	<b>OPAQUE WOOD EFFECT</b> Metal	<b>OPAQUE GREY</b> ABS	<b>OPAQUE SPACE GREY</b> Metal	<b>OPAQUE BEIGE</b> ABS	<b>OPAQUE ANTHRACITE</b> Metal

	<b>OPAQUE TAUPE GREY</b> RECYCLED PVC
---	--

Certain products may feature a blend of various materials, and in such instances, we will identify and highlight the predominant material in the product.

(\*) To ensure optimal maintenance, it is essential to shield these items from rain, direct sunlight, and abrupt temperature changes. Natural materials such as bamboo, rattan, beechwood, or seaweed may undergo color changes or develop cracks over time. When exposed to natural elements, it is advisable to regularly apply a suitable oil or varnish for each specific material. This not only extends protection against rain and UVA rays but also enhances the product's longevity. For cleaning, use a cloth or a brush to eliminate dust, and gently rub with a slightly moistened sponge.



# Use according to IP.

Here you can find information about the possible uses of Newgarden's products according to their IP (index of protection of the electrical or electronic system against external agents)

IP20

Newgarden's products with IP20 can only be used indoors, the electrical system, switches or cables must be protected from direct contact with water. Note that, although the product is made of Polyethylene, which is resistant to external agents, the electrical system is designed for **indoor use only**.



IP43

Newgarden's products with IP 43 / 44 can be used outdoors, it is protected against dust and weak and very moderate rain. **If this product also have accessories made of natural fibres, wood or metal parts, it is advisable to protect it from direct contact with water and humidity.** Store it in a dry place after use.

IP44

In the event of rain or very adverse weather conditions, it should be protected from these external agents to avoid future problems.



IP54

Newgarden's products with IP 54 **can be used outdoors, as they are protected against dust and light rain.** If this product also has accessories made of natural fibres, wood or metal parts, it is advisable to protect it from direct contact with water and humidity. Store it in a dry place after use. In case of rain or very adverse weather conditions it must be protected from these external agents to avoid future problems.



IP65

Newgarden's products with IP 65 **can be used outdoors, they are airtight against dust and rain.** If this product also has accessories made of natural fibres, wood or metal parts, it is advisable to protect it from direct contact with water and humidity. Store it in a dry place after use. In case of rain or very adverse weather conditions it must be protected from these external agents to avoid future problems.



IP67

Newgarden products with IP67 are dust-tight and rainproof. They are also floating (submersion is not recommended) so they can be used in swimming pools. They must be protected against very adverse weather conditions.

IP68

Newgarden products with IP68 are dust-tight and rainproof. They are also floating and submersible (according to each product's own instructions for use) so they can be used in swimming pools. They must be protected against very adverse weather conditions.

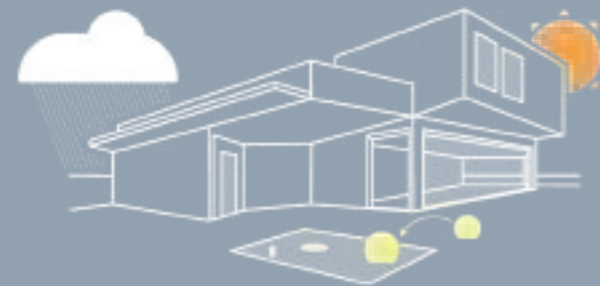



The possible differences between the original color, illumination and color captured are due to the printing technique.

NEWGARDEN reserves the right over photographs and designs made, so it is forbidden the manufacture, distribution and / or marketing of the products shown on any media.

NEWGARDEN reserves the right to modify, in whole or in part, without prior notice, any information or technical specification of this publication.

All the information that appears in this catalog in terms of dimensions and capacity are approximate and are susceptible to variations due to improvements in the production process.

#BeHappy

@ Copyright. 2024. Newgarden Spain.

Todos los derechos reservados

**Avenida de Francia, 5-15 30840  
Alhama de Murcia. Murcia (Spain)  
info@newgarden.es  
www.newgarden.es  
T. +34 968978806**